

COPA BRASIL INTERNACIONAL 2014



RIO DE JANEIRO (BRA)

2014-11-27 - 2014-11-29 2014

Résultats - Results

Lutte Libre - Free-Style





Liste des arbitres / Referee list

COPA BRASIL INTERNACIONAL 2014

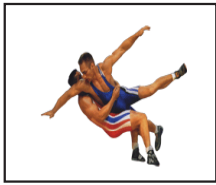

<i>N°</i>	<i>Licence</i>	<i>Pays</i> <i>Country</i>	<i>Nom - Last Name</i>	<i>Prénom - First Name</i>
-----------	----------------	-------------------------------	------------------------	----------------------------



Liste des nations / Countries List

COPA BRASIL INTERNACIONAL 2014

STYLE FS

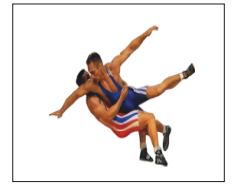

Pays - Country

	ARGENTINA	ARG
	BRAZIL	BRA
	CANADA	CAN
	CHILE	CHI
	ECUADOR	ECU
	JAPAN	JPN
	PERU	PER
	RUSSIA	RUS
	UNITED STATES	USA

Nombre de nations - Number of Countries

**Nombre d'engagés par nation / Number of Entries By Country****COPA BRASIL INTERNACIONAL 2014**

STYLE FS



<i>Pays - Country</i>	125 KG	57 KG	61 KG	65 KG	70 KG	74 KG	86 KG	97 KG	TOTAL
ARG	1			1		2			4
BRA	1	5	2	2	5	3	5	1	24
CAN		1					1	1	3
CHI		1				1			2
ECU		2			1		1		4
JPN		1	1	1	1	1	1	1	7
PER				2			1		3
RUS	2	2	2	2	2	2	2	2	16
USA	1	2	1		2	1	1	2	10
TOTAL	5	14	6	8	11	10	12	7	73

Nombre de nations - Number of Countries **9**

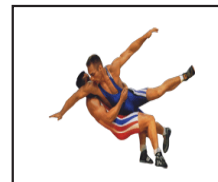
**Liste des Engagés par pays / Entry-List By Country****COPA BRASIL INTERNACIONAL 2014****STYLE FS****ARGENTINA (ARG)****Lutteur(s) / Wrestler(s) :**

125 kg	DEL RIO, LUCIANO
65 kg	PAVON, LUCAS
74 kg	LLANO, JORGE IVAN OLIVERA, ELIAS

BRAZIL (BRA)**Lutteur(s) / Wrestler(s) :**

125 kg	GRACIE, ROLLES
57 kg	JUNIOR, UZIEL MURTA, CARLOS NASCIMENTO, ALLAN SALLES, RAFAEL SILVA, WELLINGTON
61 kg	CARVALHO, JULIANO FALABELLA, RODRIGO
65 kg	EL ASSY, WILLIAM SOUZA, WALDECI
70 kg	ARAUJO, PABLO CAMARGO, VINICIUS FERNANDES, MATHEUS LUCAS, MARLON VIEIRA, DUGLAS
74 kg	MATOS, ALLAN ROCHA, PEDRO SILVA, GIVALDO
86 kg	GRACIE, IGOR GRACIE, GREGOR JAOUDE, ADRIAN NOBREGA, JONATAS SOUZA, PAULO
97 kg	BITTENCOURT, JUAN

CANADA (CAN)**Lutteur(s) / Wrestler(s) :**

57 kg	TAKAHASHI, STEVEN
86 kg	STEEN, JORDAN
97 kg	SANDHU, MANJOT

CHILE (CHI)**Lutteur(s) / Wrestler(s) :**

57 kg	QUISPE, ANDRES
-------	----------------

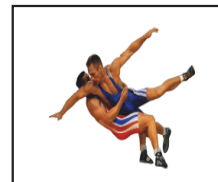
**Liste des Engagés par pays / Entry-List By Country****COPA BRASIL INTERNACIONAL 2014****STYLE FS**

74 kg

GAJARDO, EDUADO

ECUADOR (ECU)**Lutteur(s) / Wrestler(s) :**

57 kg

CEDEÃ'O, RONNY
MAYEA, JEFFERSON

70 kg

BLANCO, YOAN

86 kg

MERCADO, JOSE

JAPAN (JPN)**Lutteur(s) / Wrestler(s) :**

57 kg

OSHIRO, ISSEI

61 kg

NAKATA, YO

65 kg

TANAKA, KOTARO

70 kg

HOSAKA, KEN

74 kg

OKUI, MAO

86 kg

MATSUSAKA, MASAO

97 kg

YOSHIKAWA, YUSUKE

PERU (PER)**Lutteur(s) / Wrestler(s) :**

65 kg

PEDRAGAS, SIXTO
VARE, ABRAHAM

86 kg

GREYFO, POOL

RUSSIA (RUS)**Lutteur(s) / Wrestler(s) :**

125 kg

BAKHMUDKADIEV, ISLAM
KHUBULOV, KAZBEK

57 kg

BADRUDINOV, KHASANKHUSEYN
TUITRIN, ARYIAN

61 kg

AMPAR, RUSTAM
KUULAR, NACHYN

65 kg

DZHALILOV, SHIKSAID
SIDAKOV, ZAURBEK

70 kg

LAMPEZHEV, MULID
UMARPASHAEV, EMI

74 kg

TSABOLOV, KHETIK
VARAEV, AKHMED



Liste des Engagés par pays / Entry-List By Country

COPA BRASIL INTERNACIONAL 2014

STYLE FS



86 kg	KCOEV, SOSLAN RADZHABOV, GADZHI
97 kg	MAGOMEDOV, RASUL URISHEV, ANZOR

UNITED STATES (USA)

Lutteur(s) / Wrestler(s) :

125 kg	REY, ZACH
57 kg	HOCHSTRASSER, ANDREW MCDONOUGH, MATT
61 kg	MCKENNA, JOE
70 kg	MASSA, LOGAN RUSCHELL, KYLE
74 kg	VALENCIA, ANTHONY
86 kg	FOSTER, CLAYTON
97 kg	BERGMAN, JAMES KILGORE, DUSTIN



Feuille de compétition / Competition Sheet

COPA BRASIL INTERNACIONAL 2014

STYLE : FS 125 kg



TOUR : 1

1	$\frac{3}{5}$	BAKHMUDKADIEV I. (RUS)	P1	P2	P3	1	BAKHMUDKADIEV I. (RUS)
			5	0	0		
2	$\frac{1}{1}$	KHUBULOV KAZBEK (RUS)	P1	P2	P3		
			1	0	0		
3	$\frac{0}{0}$	DEL RIO LUCIANO (ARG)	P1	P2	P3	4	REY ZACH (USA)
			0	0	0		
4	$\frac{4}{0}$	REY ZACH (USA)	P1	P2	P3		
			0	0	0		

TOUR : 2

5	$\frac{0}{0}$	GRACIE ROLLES (BRA)	P1	P2	P3	1	BAKHMUDKADIEV I. (RUS)
			0	0	0		
1	$\frac{4}{2}$	BAKHMUDKADIEV I. (RUS)	P1	P2	P3		
			2	0	0		
2	$\frac{4}{0}$	KHUBULOV KAZBEK (RUS)	P1	P2	P3	2	KHUBULOV KAZBEK (RUS)
			0	0	0		
3	$\frac{0}{0}$	DEL RIO LUCIANO (ARG)	P1	P2	P3		
			0	0	0		

TOUR : 3

4	$\frac{3}{4}$	REY ZACH (USA)	P1	P2	P3	4	REY ZACH (USA)
			4	0	0		
1	$\frac{1}{1}$	BAKHMUDKADIEV I. (RUS)	P1	P2	P3		
			1	0	0		
5	$\frac{1}{8}$	GRACIE ROLLES (BRA)	P1	P2	P3	2	KHUBULOV KAZBEK (RUS)
			8	0	0		
2	$\frac{4}{10}$	KHUBULOV KAZBEK (RUS)	P1	P2	P3		
			10	0	0		

TOUR : 4

3	$\frac{0}{0}$	DEL RIO LUCIANO (ARG)	P1	P2	P3	1	BAKHMUDKADIEV I. (RUS)
			0	0	0		
1	$\frac{4}{0}$	BAKHMUDKADIEV I. (RUS)	P1	P2	P3		
			0	0	0		
4	$\frac{4}{10}$	REY ZACH (USA)	P1	P2	P3	4	REY ZACH (USA)
			10	0	0		
5	$\frac{0}{0}$	GRACIE ROLLES (BRA)	P1	P2	P3		
			0	0	0		

TOUR : 5

2	$\frac{0}{0}$	KHUBULOV KAZBEK (RUS)	P1	P2	P3	4	REY ZACH (USA)
			0	0	0		
4	$\frac{4}{9}$	REY ZACH (USA)	P1	P2	P3		
			9	0	0		
3	$\frac{0}{0}$	DEL RIO LUCIANO (ARG)	P1	P2	P3	5	GRACIE ROLLES (BRA)
			0	0	0		
5	$\frac{4}{0}$	GRACIE ROLLES (BRA)	P1	P2	P3		
			0	0	0		

Classement

Cl	Pays	Nom	Points
1	USA	REY ZACH	15
2	RUS	BAKHMUDKADIEV ISLAM	12
3	RUS	KHUBULOV KAZBEK	9
4	BRA	GRACIE ROLLES	5
5	ARG	DEL RIO LUCIANO	0



Classement

COPA BRASIL INTERNACIONAL 2014

STYLE : FS 125 kg



1 - Or / Gold



REY ZACH

2 - Argent / Silver



BAKHMUDKADIEV ISLAM

3 - Bronze



KHUBULOV KAZBEK

<i>Classement</i>	<i>Nom - Name</i>	<i>Pays - Country</i>	<i>Points</i>
1	REY ZACH	USA	15
2	BAKHMUDKADIEV ISLAM	RUS	12
3	KHUBULOV KAZBEK	RUS	9
4	GRACIE ROLLES	BRA	5
5	DEL RIO LUCIANO	ARG	0



Feuille de compétition / Competition Sheet

COPA BRASIL INTERNACIONAL 2014



STYLE : FS 57 kg



Classement		
Cl	Pays	Nom
1	USA	HOCHSTRASSER ANDREW
2	RUS	BADRUDINOV KHASANKHUSEYN
3	USA	MCDONOUGH MATT
3	CAN	TAKAHASHI STEVEN
5	JPN	OSHIRO ISSEI
5	CHI	QUISPE ANDRES
7	BRA	SALLES RAFAEL
8	RUS	TUITRIN ARYIAN
9	ECU	MAYEA JEFFERSON
10	BRA	NASCIMENTO ALLAN
11	ECU	CEDEÁ'O RONNY
11	BRA	SILVA WELLINGTON
13	BRA	JUNIOR UZIEL
14	BRA	MURTA CARLOS

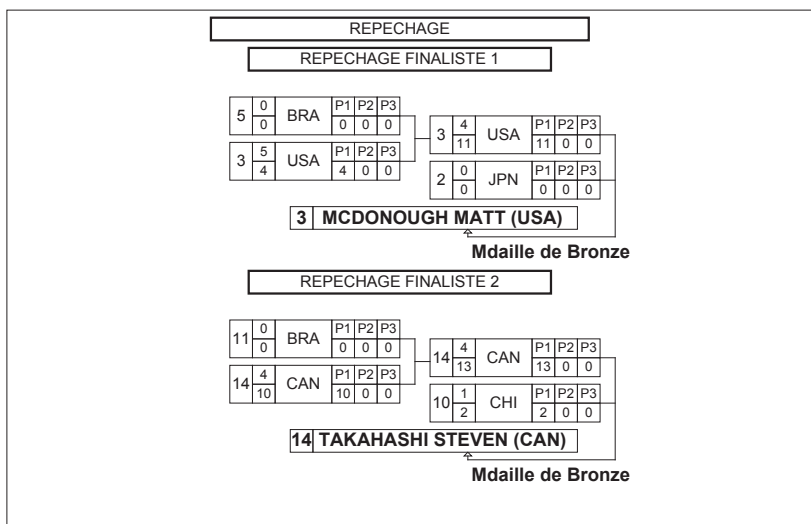



Classement

COPA BRASIL INTERNACIONAL 2014

STYLE : FS 57 kg



1 - Or / Gold



HOCHSTRASSER ANDREW

2 - Argent / Silver



BADRUDINOV KHASANKHUSEYN

3 - Bronze



MCDONOUGH MATT



TAKAHASHI STEVEN

Classement	Nom - Name	Pays - Country
1	HOCHSTRASSER ANDREW	USA
2	BADRUDINOV K.	RUS
3	MCDONOUGH MATT	USA
3	TAKAHASHI STEVEN	CAN
5	OSHIRO ISSEI	JPN
5	QUISPE ANDRES	CHI
7	SALLES RAFAEL	BRA
8	TUITRIN ARYIAN	RUS
9	MAYEA JEFFERSON	ECU
10	NASCIMENTO ALLAN	BRA
11	CEDEÃO RONNY	ECU
11	SILVA WELLINGTON	BRA
13	JUNIOR UZIEL	BRA
14	MURTA CARLOS	BRA



Feuille de compétition / Competition Sheet

COPA BRASIL INTERNACIONAL 2014

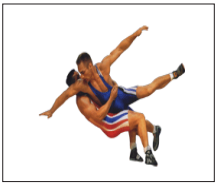

STYLE : FS 61 kg

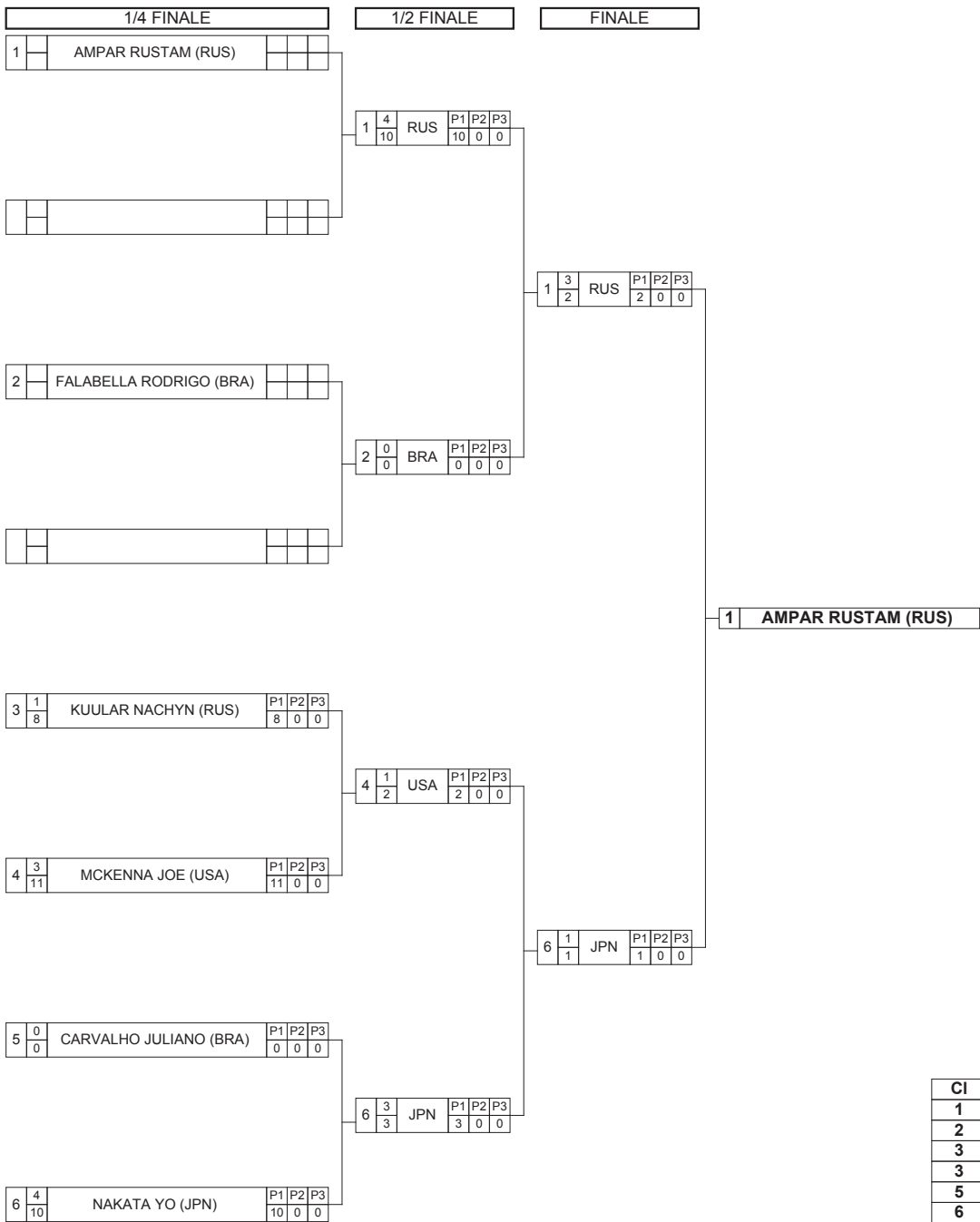

Classement

Cl	Pays	Nom
1	RUS	AMPAR RUSTAM
2	JPN	NAKATA YO
3	BRA	FALABELLA RODRIGO
3	USA	MCKENNA JOE
5	BRA	CARVALHO JULIANO
6	RUS	KUULAR NACHYN

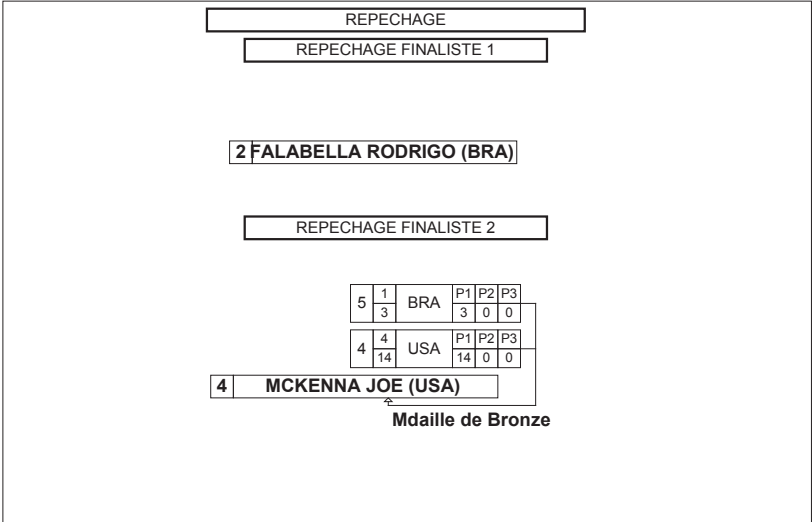



Classement

COPA BRASIL INTERNACIONAL 2014

STYLE : FS 61 kg



1 - Or / Gold



AMPAR RUSTAM

2 - Argent / Silver



NAKATA YO

3 - Bronze



FALABELLA RODRIGO



MCKENNA JOE

<i>Classement</i>	<i>Nom - Name</i>	<i>Pays - Country</i>
1	AMPAR RUSTAM	RUS
2	NAKATA YO	JPN
3	FALABELLA RODRIGO	BRA
3	MCKENNA JOE	USA
5	CARVALHO JULIANO	BRA
6	KUULAR NACHYN	RUS



Feuille de compétition / Competition Sheet

COPA BRASIL INTERNACIONAL 2014

STYLE : FS 65 kg

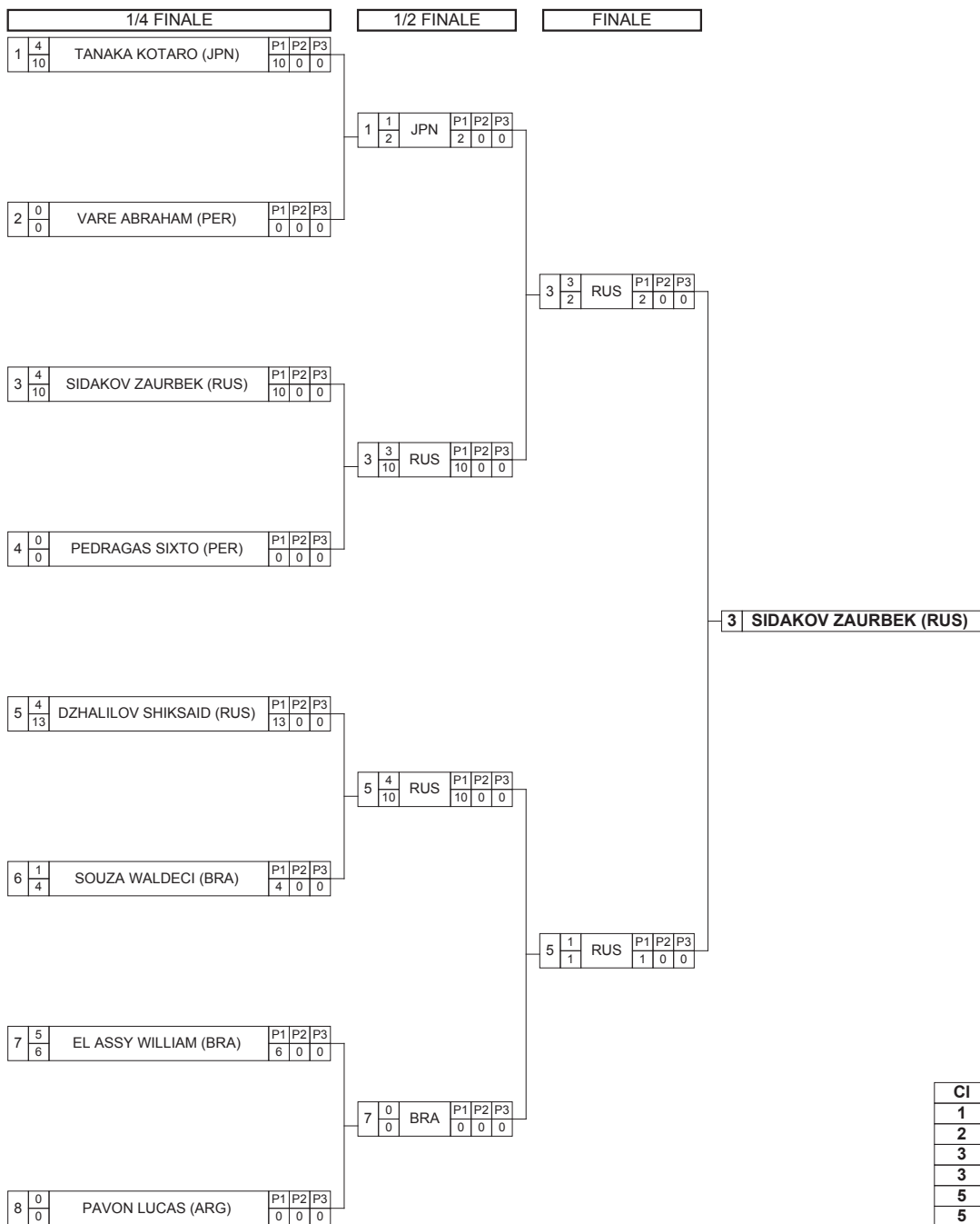
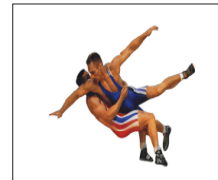

Classement

Cl	Pays	Nom
1	RUS	SIDAKOV ZAURBEK
2	RUS	DZHALILOV SHIKSAID
3	JPN	TANAKA KOTARO
3	BRA	EL ASSY WILLIAM
5	PER	PEDRAGAS SIXTO
5	BRA	SOUZA WALDECI
7	ARG	PAVON LUCAS
8	PER	VARE ABRAHAM

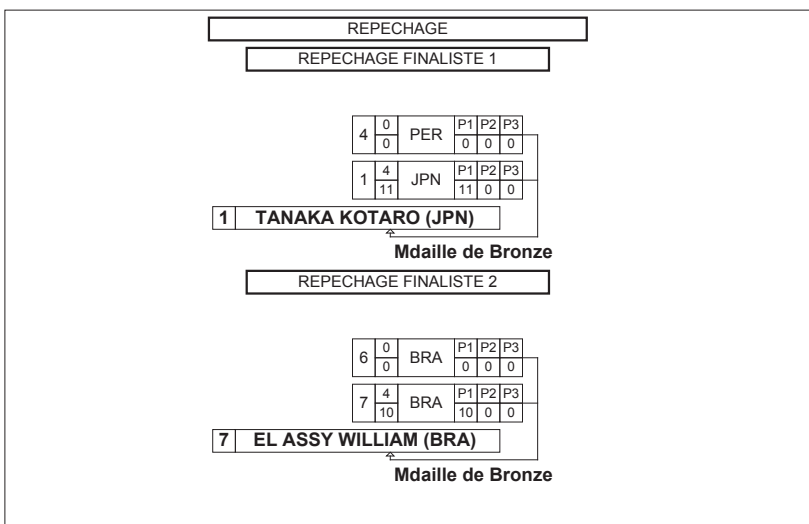



Classement

COPA BRASIL INTERNACIONAL 2014

STYLE : FS 65 kg



1 - Or / Gold



SIDAKOV ZAURBEK

2 - Argent / Silver



DZHALILOV SHIKSAID

3 - Bronze



TANAKA KOTARO



EL ASSY WILLIAM

Classement	Nom - Name	Pays - Country
1	SIDAKOV ZAURBEK	RUS
2	DZHALILOV SHIKSAID	RUS
3	TANAKA KOTARO	JPN
3	EL ASSY WILLIAM	BRA
5	PEDRAGAS SIXTO	PER
5	SOUZA WALDECI	BRA
7	PAVON LUCAS	ARG
8	VARE ABRAHAM	PER



Feuille de compétition / Competition Sheet

COPA BRASIL INTERNACIONAL 2014



STYLE : FS 70 kg

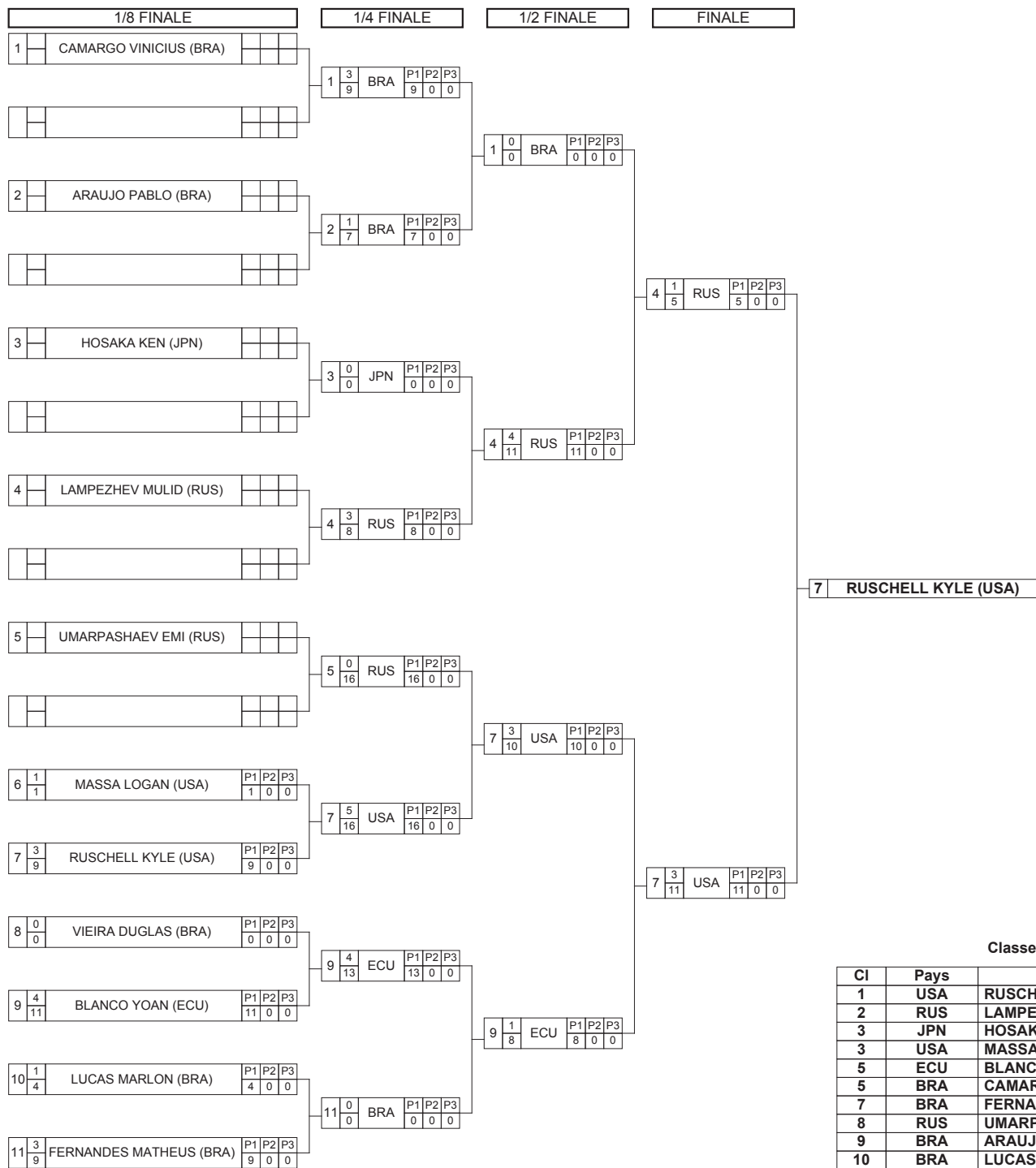

Classement

Cl	Pays	Nom
1	USA	RUSCHELL KYLE
2	RUS	LAMPEZHEV MULID
3	JPN	HOSAKA KEN
3	USA	MASSA LOGAN
5	ECU	BLANCO YOAN
5	BRA	CAMARGO VINICIUS
7	BRA	FERNANDES MATHEUS
8	RUS	UMARPASHAEV EMI
9	BRA	ARAUJO PABLO
10	BRA	LUCAS MARLON
11	BRA	VIEIRA DUGLAS

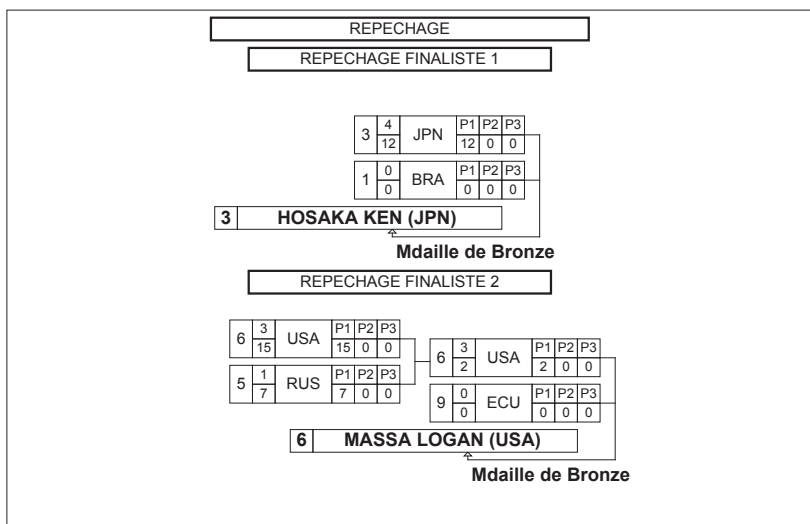



Classement

COPA BRASIL INTERNACIONAL 2014

STYLE : FS 70 kg



1 - Or / Gold



RUSCHELL KYLE

2 - Argent / Silver



LAMPEZHEV MULID

3 - Bronze



HOSAKA KEN



MASSA LOGAN

Classement	Nom - Name	Pays - Country
1	RUSCHELL KYLE	USA
2	LAMPEZHEV MULID	RUS
3	HOSAKA KEN	JPN
3	MASSA LOGAN	USA
5	BLANCO YOAN	ECU
5	CAMARGO VINICIUS	BRA
7	FERNANDES MATHEUS	BRA
8	UMARPASHAEV EMI	RUS
9	ARAUJO PABLO	BRA
10	LUCAS MARLON	BRA
11	VIEIRA DUGLAS	BRA



Feuille de compétition / Competition Sheet

COPA BRASIL INTERNACIONAL 2014



STYLE : FS 74 kg

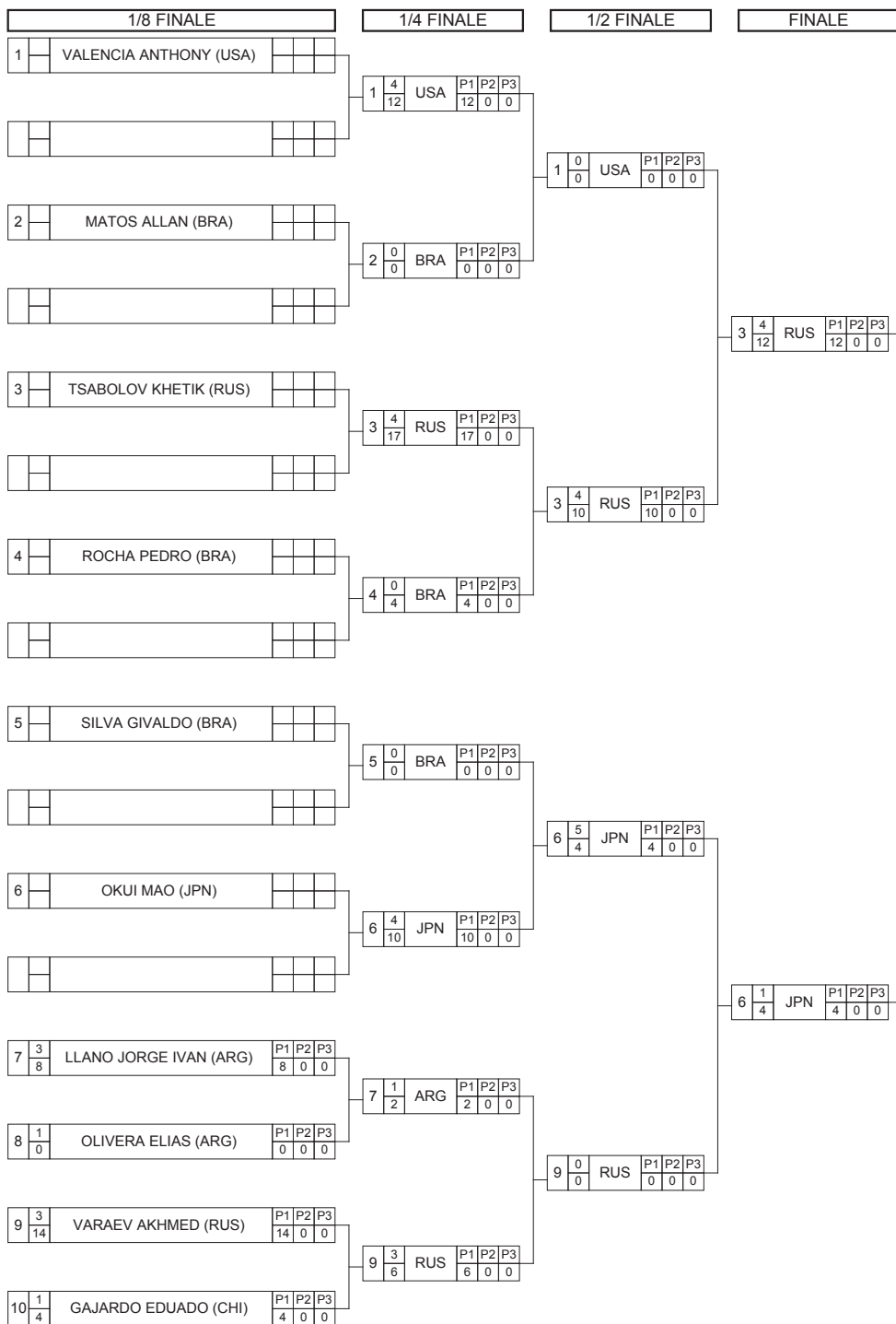

3 TSABOLOV KHETIK (RUS)

Classement

Cl	Pays	Nom
1	RUS	TSABOLOV KHETIK
2	JPN	OKUI MAO
3	USA	VALENCIA ANTHONY
3	RUS	VARAEV AKHMED
5	BRA	SILVA GIVALDO
5	BRA	ROCHA PEDRO
7	ARG	LLANO JORGE IVAN
8	CHI	GAJARDO EDUADO
9	ARG	OLIVERA ELIAS
10	BRA	MATOS ALLAN

REPECHAGE

REPECHAGE FINALISTE 1

4	1 2	BRA	P1 2	P2 0	P3 0
1	4 14	USA	P1 14	P2 0	P3 0

1 VALENCIA ANTHONY (USA)

Mdaille de Bronze

REPECHAGE FINALISTE 2

5	0 0	BRA	P1 0	P2 0	P3 0
9	4 10	RUS	P1 10	P2 0	P3 0

9 VARAEV AKHMED (RUS)

Mdaille de Bronze



Classement

COPA BRASIL INTERNACIONAL 2014

STYLE : FS 74 kg



1 - Or / Gold



TSABOLOV KHETIK

2 - Argent / Silver



OKUI MAO

3 - Bronze



VALENCIA ANTHONY



VARAEV AKHMED

Classement	Nom - Name	Pays - Country
1	TSABOLOV KHETIK	RUS
2	OKUI MAO	JPN
3	VALENCIA ANTHONY	USA
3	VARAEV AKHMED	RUS
5	SILVA GIVALDO	BRA
5	ROCHA PEDRO	BRA
7	LLANO JORGE IVAN	ARG
8	GAJARDO EDUADO	CHI
9	OLIVERA ELIAS	ARG
10	MATOS ALLAN	BRA



Feuille de compétition / Competition Sheet

COPA BRASIL INTERNACIONAL 2014



STYLE : FS 86 kg

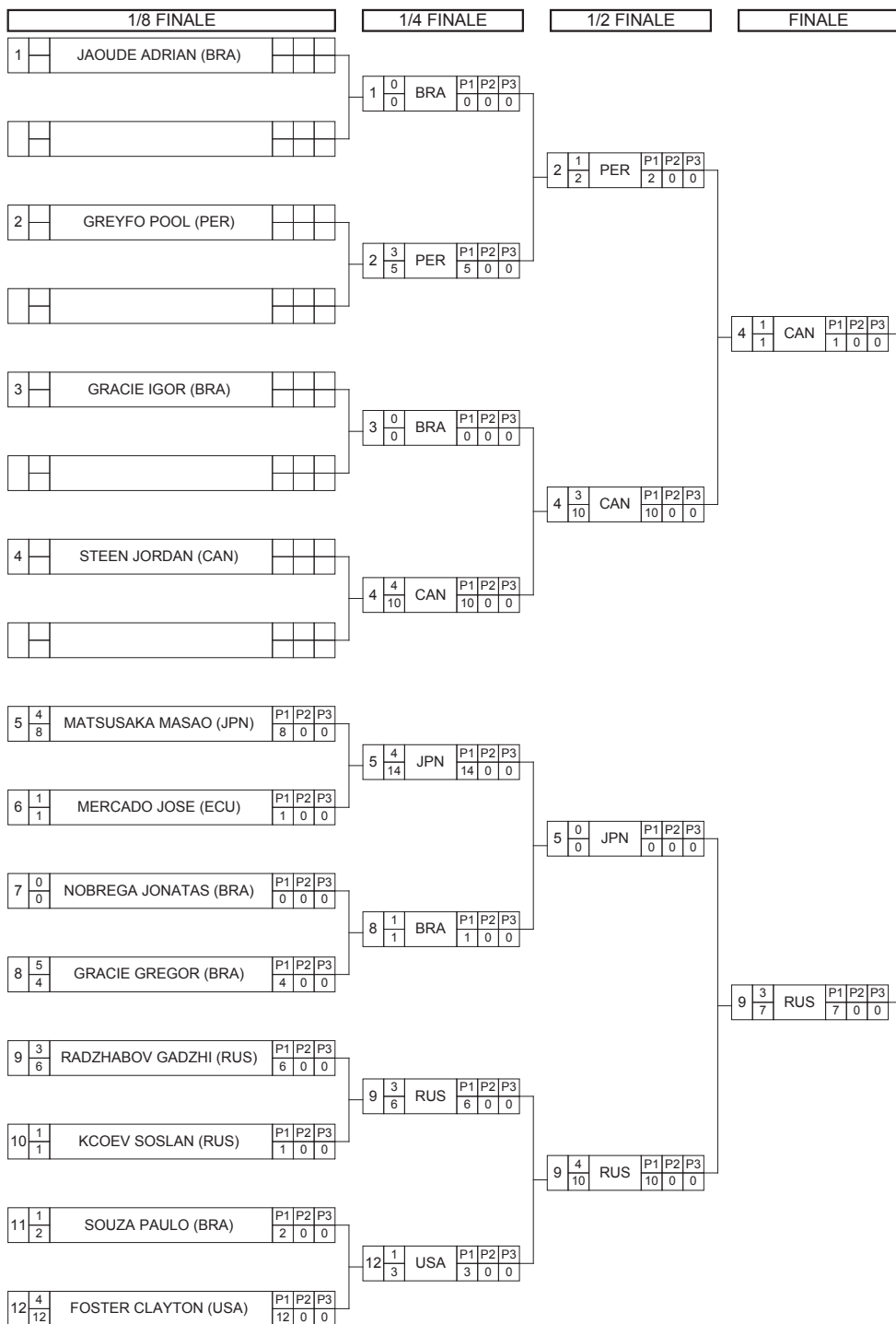

9 RADZHABOV GADZHI (RUS)

Classement

Cl	Pays	Nom
1	RUS	RADZHABOV GADZHI
2	CAN	STEEN JORDAN
3	PER	GREYFO POOL
3	USA	FOSTER CLAYTON
5	BRA	GRACIE IGOR
5	JPN	MATSUSAKA MASAO
7	BRA	GRACIE GREGOR
8	BRA	SOUZA PAULO
9	RUS	KCOEV SOSLAN
10	ECU	MERCADO JOSE
11	BRA	NOBREGA JONATAS
12	BRA	JAOUDE ADRIAN

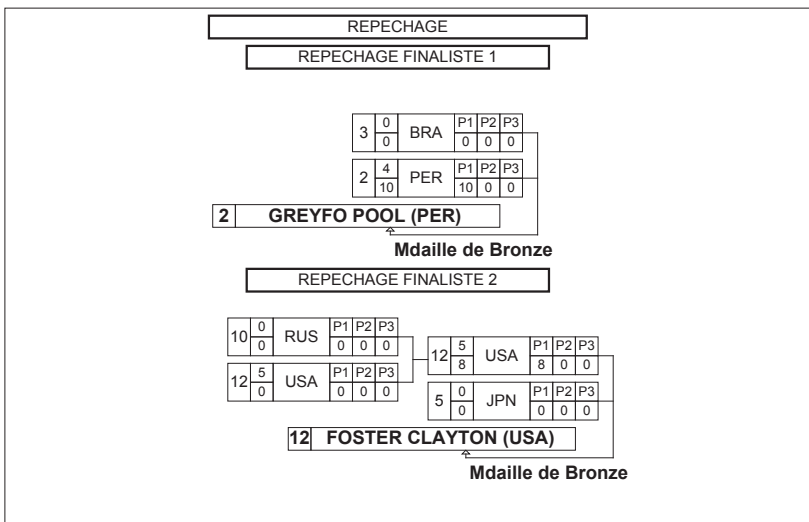



Classement

COPA BRASIL INTERNACIONAL 2014

STYLE : FS 86 kg



1 - Or / Gold



RADZHABOV GADZHI

2 - Argent / Silver



STEEN JORDAN

3 - Bronze



GREYFO POOL



FOSTER CLAYTON

<i>Classement</i>	<i>Nom - Name</i>	<i>Pays - Country</i>
1	RADZHABOV GADZHI	RUS
2	STEEN JORDAN	CAN
3	GREYFO POOL	PER
3	FOSTER CLAYTON	USA
5	GRACIE IGOR	BRA
5	MATSUSAKA MASAO	JPN
7	GRACIE GREGOR	BRA
8	SOUZA PAULO	BRA
9	KCOEV SOSLAN	RUS
10	MERCADO JOSE	ECU
11	NOBREGA JONATAS	BRA
12	JAOUDE ADRIAN	BRA



Feuille de compétition / Competition Sheet

COPA BRASIL INTERNACIONAL 2014

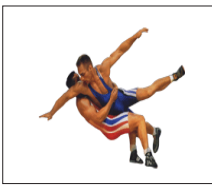

STYLE : FS 97 kg

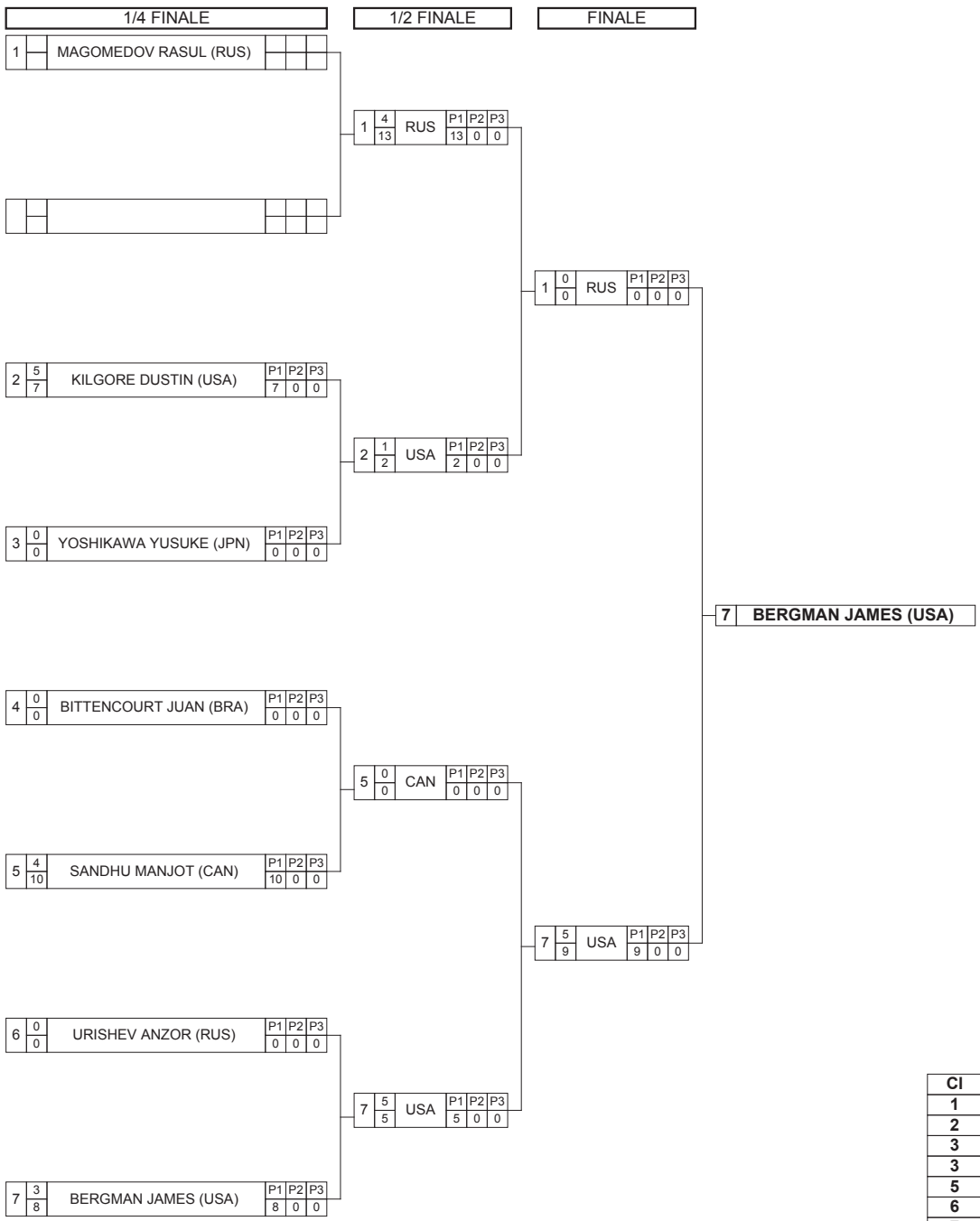

Classement

Cl	Pays	Nom
1	USA	BERGMAN JAMES
2	RUS	MAGOMEDOV RASUL
3	USA	KILGORE DUSTIN
3	RUS	URISHEV ANZOR
5	CAN	SANDHU MANJOT
6	JPN	YOSHIKAWA YUSUKE
7	BRA	BITTENCOURT JUAN

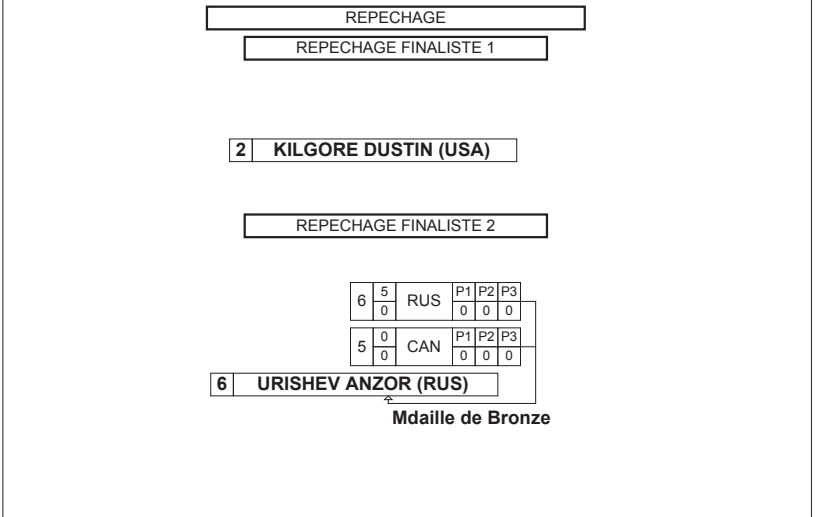



Classement

COPA BRASIL INTERNACIONAL 2014

STYLE : FS 97 kg



1 - Or / Gold



BERGMAN JAMES

2 - Argent / Silver



MAGOMEDOV RASUL

3 - Bronze



KILGORE DUSTIN



URISHEV ANZOR

Classement	Nom - Name	Pays - Country
1	BERGMAN JAMES	USA
2	MAGOMEDOV RASUL	RUS
3	KILGORE DUSTIN	USA
3	URISHEV ANZOR	RUS
5	SANDHU MANJOT	CAN
6	YOSHIKAWA YUSUKE	JPN
7	BITTENCOURT JUAN	BRA

**Classement par équipe / Teams ranking****COPA BRASIL INTERNACIONAL 2014**

STYLE FS



Rang	Equipe	125 KG	57 KG	61 KG	65 KG	70 KG	74 KG	86 KG	97 KG	TOTAL
1	RUS	17	12	15	19	12	18	12	17	122
2	USA	10	18	8		18	8	8	18	88
3	BRA	7	5	14	14	13	13	13	4	83
4	JPN		6	9	8	8	9	6	5	51
5	CAN		8					9	6	23
6	PER				9			8		17
7	ARG	6			4		6			16
8	CHI		6				3			9
9	ECU		2			6		1		9

COPA BRASIL INTERNACIONAL 2014



RIO DE JANEIRO (BRA)

2014-11-27 - 2014-11-29 2014

Résultats - Results

Lutte Féminine - Female-Wrestling





Liste des arbitres / Referee list

COPA BRASIL INTERNACIONAL 2014



<i>N°</i>	<i>Licence</i>	<i>Pays Country</i>	<i>Nom - Last Name</i>	<i>Prénom - First Name</i>
-----------	----------------	-------------------------	------------------------	----------------------------





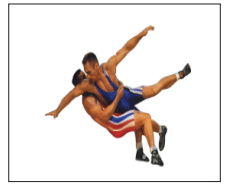

Liste des nations / Countries List

COPA BRASIL INTERNACIONAL 2014

STYLE FW



Pays - Country

	ARGENTINA	ARG
	BRAZIL	BRA
	CANADA	CAN
	CHILE	CHI
	ECUADOR	ECU
	JAPAN	JPN
	PERU	PER

Nombre de nations - Number of Countries

**Nombre d'engagés par nation / Number of Entries By Country****COPA BRASIL INTERNACIONAL 2014**

STYLE FW

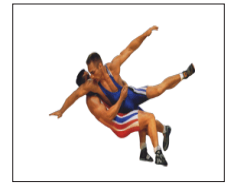

Pays - Country	48 KG	53 KG	55 KG	58 KG	60 KG	63 KG	69 KG	75 KG	TOTAL
ARG	1								1
BRA	4	3	2	1	4	2	2	2	20
CAN	2	2		1	1	4	3	2	15
CHI	1								1
ECU	2	1		1					4
JPN		1	1	1	1	2		1	7
PER	1	1		1		1	1		5
TOTAL	11	8	3	5	6	9	6	5	53

Nombre de nations - Number of Countries **7**



Liste des Engagés par pays / Entry-List By Country

COPA BRASIL INTERNACIONAL 2014

STYLE FW

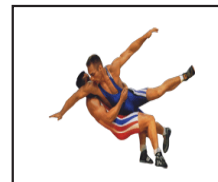

ARGENTINA (ARG)

Lutteuse(s) / Wrestler(s) :

48 kg CABRERA, CLAUDIA

BRAZIL (BRA)

Lutteuse(s) / Wrestler(s) :

48 kg BARBOSA, KAMILA
PERES, FERNANDA
SANTOS, SUSANA
SOARES, CAROLINE

53 kg ALVES, GRACYENNE
OLIVEIRA, GIULIA
TRISTAO, CAMILA

55 kg GRACIANO, MAYARA
SANTOS, TACIANE

58 kg SILVA, JOICE

60 kg CAVALCANTE, CAROLINE
JULIO, JOSIMARA
PALHETA, BRENDA
SOUZA, ALINE

63 kg OLIVEIRA, LAIS
REIS, DAILANE

69 kg OLIVEIRA, GILDA
PEREIRA, RAFAELA

75 kg FERREIRA, ALINE
SILVA, KEILA

CANADA (CAN)

Lutteuse(s) / Wrestler(s) :

48 kg KRAMBLE, NATASHA
MAIN, JASMINE

53 kg GALLAYS, JILLIAN
STEWART, SAMANTHA

58 kg BOUCHARD, JUSTINE

60 kg FAZZARI, MICHELLE

63 kg ANAKA, STACIE
DELLVA, LARISSA
GRAHAM, BREANNE
STONE, BRAXTON

69 kg DISTASIO, JUSTINA
GOBLE, HILARY
YEATS, DOROTHY

75 kg KEEFE, VERONICA
WIEBE, ERICA



Liste des Engagés par pays / Entry-List By Country

COPA BRASIL INTERNACIONAL 2014

STYLE FW

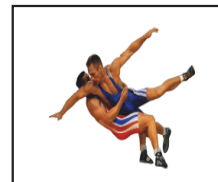

CHILE (CHI)

Lutteuse(s) / Wrestler(s) :

48 kg PERIZ, DANIELA

ECUADOR (ECU)

Lutteuse(s) / Wrestler(s) :

48 kg BUSTOS, ANGELINA

TOALA, KATIUSKA

53 kg MOLLOCANA, JACQUELINE

58 kg ANTES, LISSETE

JAPAN (JPN)

Lutteuse(s) / Wrestler(s) :

53 kg TANAKA, ARISA

55 kg KIMURA, ANRI

58 kg HIGUCHI, MIKAKO

60 kg SAKANO, YUI

63 kg SATO, HARUKA

VEHARA, HARUNA

75 kg ABE, RINO

PERU (PER)

Lutteuse(s) / Wrestler(s) :

48 kg PECHE, THALIA

53 kg LUGO, ANA

58 kg NIÑ'Ó, YANET

63 kg BENDEZU, JESICA

69 kg ARROYO, DIANA



Feuille de compétition / Competition Sheet

COPA BRASIL INTERNACIONAL 2014

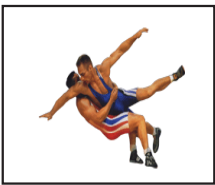

STYLE : FW 48 kg

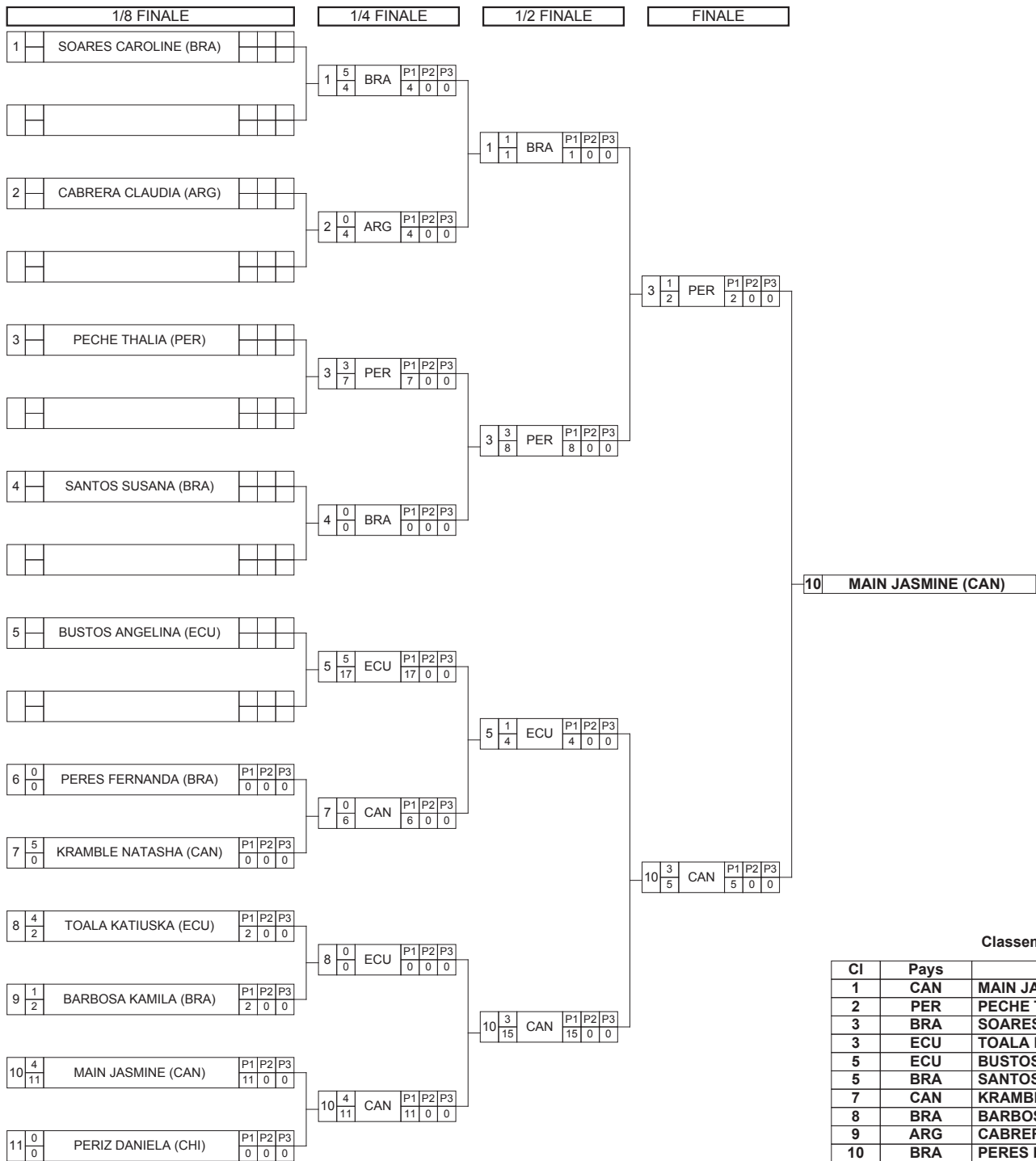

Classement

Cl	Pays	Nom
1	CAN	MAIN JASMINE
2	PER	PECHE THALIA
3	BRA	SOARES CAROLINE
3	ECU	TOALA KATIUSKA
5	ECU	BUSTOS ANGELINA
5	BRA	SANTOS SUSANA
7	CAN	KRAMBLE NATASHA
8	BRA	BARBOSA KAMILA
9	ARG	CABRERA CLAUDIA
10	BRA	PERES FERNANDA
11	CHI	PERIZ DANIELA

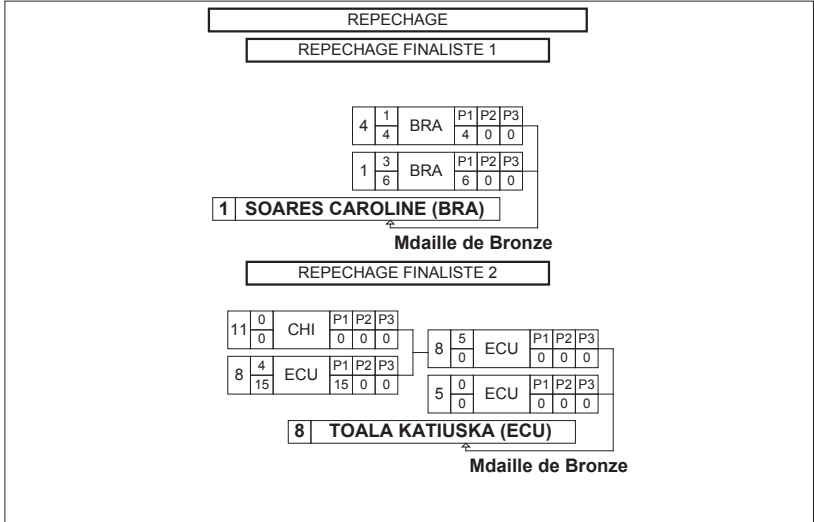



Classement

COPA BRASIL INTERNACIONAL 2014

STYLE : FW 48 kg



1 - Or / Gold



MAIN JASMINE

2 - Argent / Silver



PECHE THALIA

3 - Bronze



SOARES CAROLINE



TOALA KATIUSKA

Classement	Nom - Name	Pays - Country
1	MAIN JASMINE	CAN
2	PECHE THALIA	PER
3	SOARES CAROLINE	BRA
3	TOALA KATIUSKA	ECU
5	BUSTOS ANGELINA	ECU
5	SANTOS SUSANA	BRA
7	KRAMBLE NATASHA	CAN
8	BARBOSA KAMILA	BRA
9	CABRERA CLAUDIA	ARG
10	PERES FERNANDA	BRA
11	PERIZ DANIELA	CHI



Feuille de compétition / Competition Sheet

COPA BRASIL INTERNACIONAL 2014



STYLE : FW 53 kg

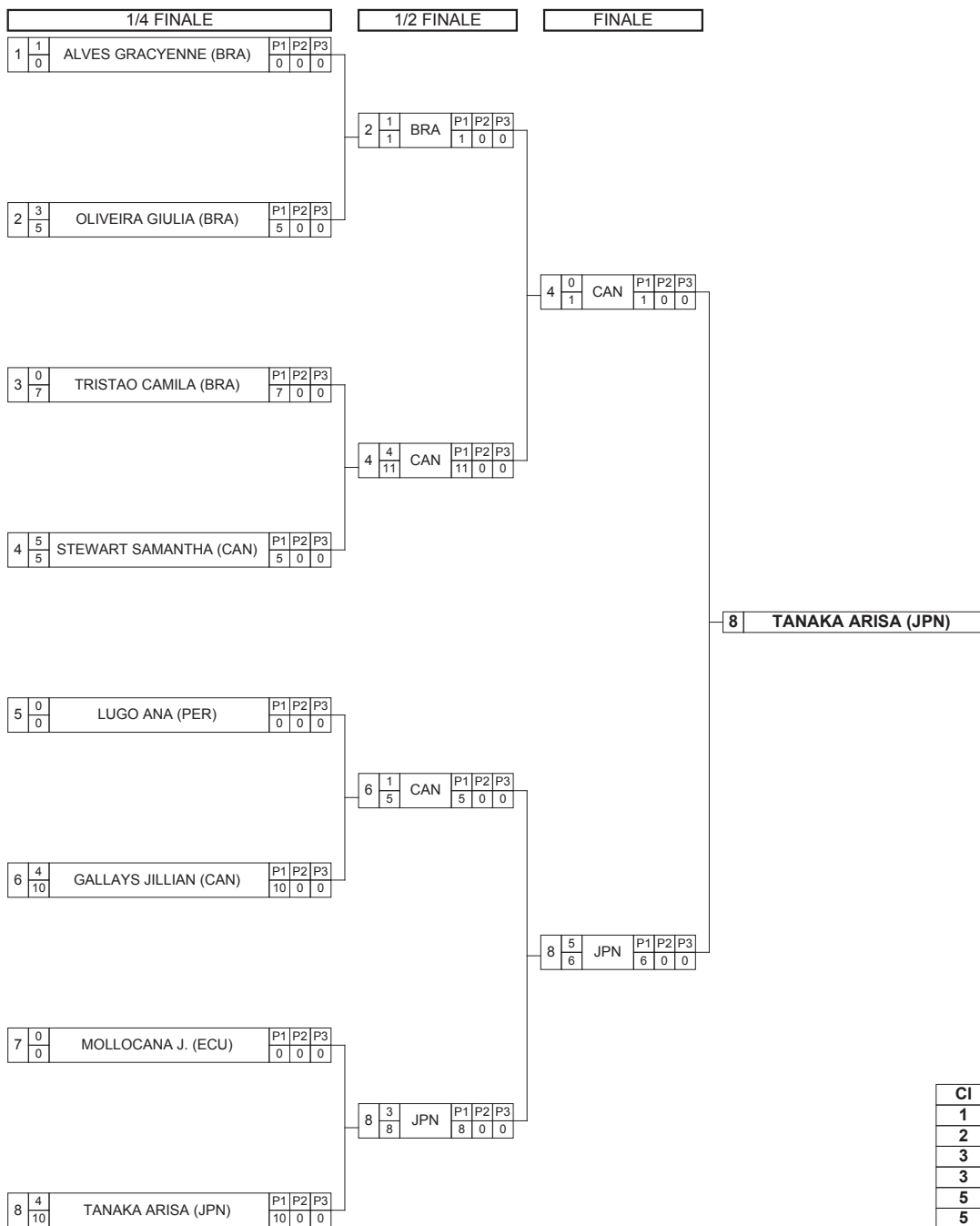

Classement

Cl	Pays	Nom
1	JPN	TANAKA ARISA
2	CAN	STEWART SAMANTHA
3	BRA	OLIVEIRA GIULIA
3	CAN	GALLAYS JILLIAN
5	BRA	TRISTAO CAMILA
5	ECU	MOLLOCANA JACQUELINE
7	BRA	ALVES GRACYENNE
8	PER	LUGO ANA

REPECHAGE

REPECHAGE FINALISTE 1

3	1 8	BRA	P1	P2	P3
			8	0	0
2	3 12	BRA	P1	P2	P3
			12	0	0

2 OLIVEIRA GIULIA (BRA)

Mdaille de Bronze

REPECHAGE FINALISTE 2

7	0 1	ECU	P1	P2	P3
			1	0	0
6	5 4	CAN	P1	P2	P3
			4	0	0

6 GALLAYS JILLIAN (CAN)

Mdaille de Bronze



Classement

COPA BRASIL INTERNACIONAL 2014

STYLE : FW 53 kg



1 - Or / Gold



TANAKA ARISA

2 - Argent / Silver



STEWART SAMANTHA

3 - Bronze



OLIVEIRA GIULIA



GALLAYS JILLIAN

<i>Classement</i>	<i>Nom - Name</i>	<i>Pays - Country</i>
1	TANAKA ARISA	JPN
2	STEWART SAMANTHA	CAN
3	OLIVEIRA GIULIA	BRA
3	GALLAYS JILLIAN	CAN
5	TRISTAO CAMILA	BRA
5	MOLLOCANA J.	ECU
7	ALVES GRACYENNE	BRA
8	LUGO ANA	PER



Feuille de compétition / Competition Sheet

COPA BRASIL INTERNACIONAL 2014

STYLE : FW 55 kg



TOUR : 1

1	4 6	KIMURA ANRI (JPN)	P1 6	P2 0	P3 0	1	KIMURA ANRI (JPN)
2	0 0	GRACIANO MAYARA (BRA)	P1 0	P2 0	P3 0		

TOUR : 2

3	0 0	SANTOS TACIANE (BRA)	P1 0	P2 0	P3 0	1	KIMURA ANRI (JPN)
1	4 6	KIMURA ANRI (JPN)	P1 6	P2 0	P3 0		

TOUR : 3

2	3 9	GRACIANO MAYARA (BRA)	P1 9	P2 0	P3 0	2	GRACIANO MAYARA (BRA)
3	1 3	SANTOS TACIANE (BRA)	P1 3	P2 0	P3 0		

Classement

Cl	Pays	Nom	Points
1	JPN	KIMURA ANRI	8
2	BRA	GRACIANO MAYARA	3
3	BRA	SANTOS TACIANE	1



Classement

COPA BRASIL INTERNACIONAL 2014

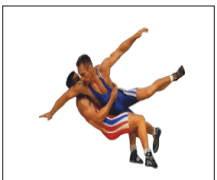

STYLE : FW 55 kg

1 - Or / Gold



KIMURA ANRI

2 - Argent / Silver



GRACIANO MAYARA

3 - Bronze



SANTOS TACIANE

<i>Classement</i>	<i>Nom - Name</i>	<i>Pays - Country</i>	<i>Points</i>
1	KIMURA ANRI	JPN	8
2	GRACIANO MAYARA	BRA	3
3	SANTOS TACIANE	BRA	1



Feuille de compétition / Competition Sheet

COPA BRASIL INTERNACIONAL 2014

STYLE : FW 58 kg



TOUR : 1

1	$\frac{1}{14}$	BOUCHARD JUSTINE (CAN)	P1	P2	P3	2	HIGUCHI MIKAKO (JPN)
			14	0	0		
2	$\frac{3}{10}$	HIGUCHI MIKAKO (JPN)	P1	P2	P3		
			10	0	0		
3	$\frac{0}{7}$	SILVA JOICE (BRA)	P1	P2	P3	4	ANTES LISSETE (ECU)
			7	0	0		
4	$\frac{4}{6}$	ANTES LISSETE (ECU)	P1	P2	P3		
			6	0	0		

TOUR : 2

5	$\frac{1}{6}$	NIÃ'O YANET (PER)	P1	P2	P3	1	BOUCHARD JUSTINE (CAN)
			6	0	0		
1	$\frac{4}{8}$	BOUCHARD JUSTINE (CAN)	P1	P2	P3		
			8	0	0		
2	$\frac{0}{0}$	HIGUCHI MIKAKO (JPN)	P1	P2	P3	3	SILVA JOICE (BRA)
			0	0	0		
3	$\frac{4}{10}$	SILVA JOICE (BRA)	P1	P2	P3		
			10	0	0		

TOUR : 3

4	$\frac{4}{12}$	ANTES LISSETE (ECU)	P1	P2	P3	4	ANTES LISSETE (ECU)
			12	0	0		
1	$\frac{1}{2}$	BOUCHARD JUSTINE (CAN)	P1	P2	P3		
			2	0	0		
5	$\frac{3}{9}$	NIÃ'O YANET (PER)	P1	P2	P3	5	NIÃ'O YANET (PER)
			9	0	0		
2	$\frac{1}{4}$	HIGUCHI MIKAKO (JPN)	P1	P2	P3		
			4	0	0		

TOUR : 4

3	$\frac{1}{4}$	SILVA JOICE (BRA)	P1	P2	P3	1	BOUCHARD JUSTINE (CAN)
			4	0	0		
1	$\frac{3}{8}$	BOUCHARD JUSTINE (CAN)	P1	P2	P3		
			8	0	0		
4	$\frac{3}{10}$	ANTES LISSETE (ECU)	P1	P2	P3	4	ANTES LISSETE (ECU)
			10	0	0		
5	$\frac{1}{6}$	NIÃ'O YANET (PER)	P1	P2	P3		
			6	0	0		

TOUR : 5

2	$\frac{0}{0}$	HIGUCHI MIKAKO (JPN)	P1	P2	P3	4	ANTES LISSETE (ECU)
			0	0	0		
4	$\frac{4}{10}$	ANTES LISSETE (ECU)	P1	P2	P3		
			10	0	0		
3	$\frac{3}{4}$	SILVA JOICE (BRA)	P1	P2	P3	3	SILVA JOICE (BRA)
			4	0	0		
5	$\frac{1}{4}$	NIÃ'O YANET (PER)	P1	P2	P3		
			4	0	0		

Classement

Cl	Pays	Nom	Points
1	ECU	ANTES LISSETE	15
2	CAN	BOUCHARD JUSTINE	9
3	BRA	SILVA JOICE	8
4	PER	NIÃ'O YANET	6
5	JPN	HIGUCHI MIKAKO	4



Classement

COPA BRASIL INTERNACIONAL 2014

STYLE : FW 58 kg



1 - Or / Gold



ANTES LISSETE

2 - Argent / Silver



BOUCHARD JUSTINE

3 - Bronze



SILVA JOICE

<i>Classement</i>	<i>Nom - Name</i>	<i>Pays - Country</i>	<i>Points</i>
1	ANTES LISSETE	ECU	15
2	BOUCHARD JUSTINE	CAN	9
3	SILVA JOICE	BRA	8
4	NIÃ'O YANET	PER	6
5	HIGUCHI MIKAKO	JPN	4



Feuille de compétition / Competition Sheet

COPA BRASIL INTERNACIONAL 2014

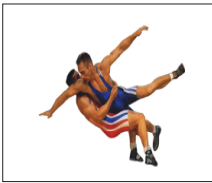

STYLE : FW 60 kg

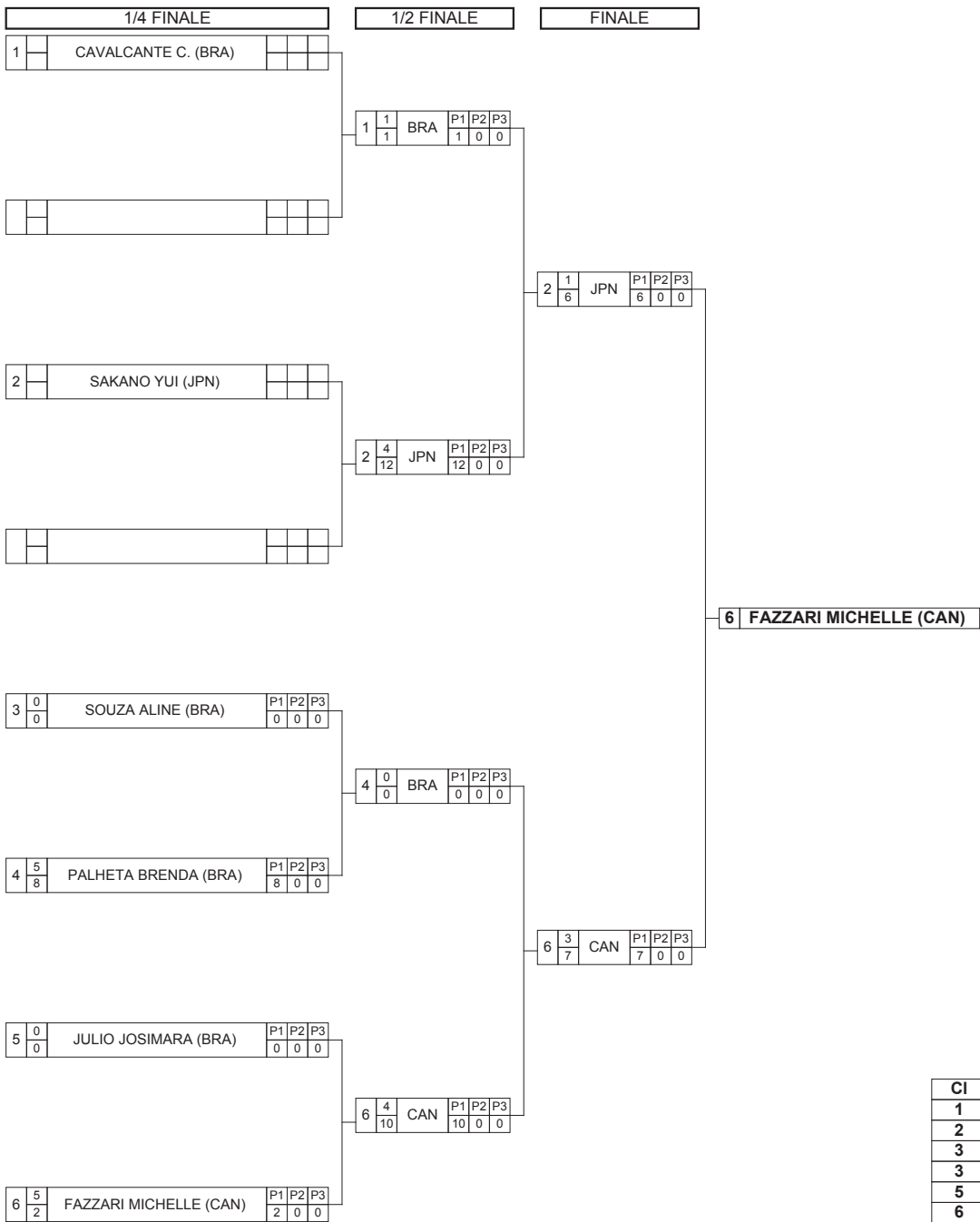

Classement

Cl	Pays	Nom
1	CAN	FAZZARI MICHELLE
2	JPN	SAKANO YUI
3	BRA	CAVALCANTE CAROLINE
3	BRA	JULIO JOSIMARA
5	BRA	PALHETA BRENDA
6	BRA	SOUZA ALINE

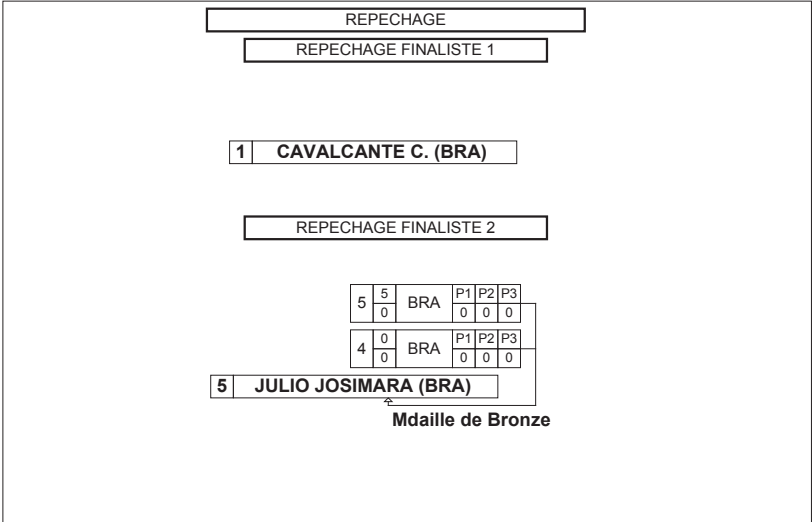



Classement

COPA BRASIL INTERNACIONAL 2014

STYLE : FW 60 kg



1 - Or / Gold



FAZZARI MICHELLE

2 - Argent / Silver



SAKANO YUI

3 - Bronze



CAVALCANTE CAROLINE



JULIO JOSIMARA

Classement	Nom - Name	Pays - Country
1	FAZZARI MICHELLE	CAN
2	SAKANO YUI	JPN
3	CAVALCANTE CAROLINE	BRA
3	JULIO JOSIMARA	BRA
5	PALHETA BRENDA	BRA
6	SOUZA ALINE	BRA



Feuille de compétition / Competition Sheet

COPA BRASIL INTERNACIONAL 2014



STYLE : FW 63 kg

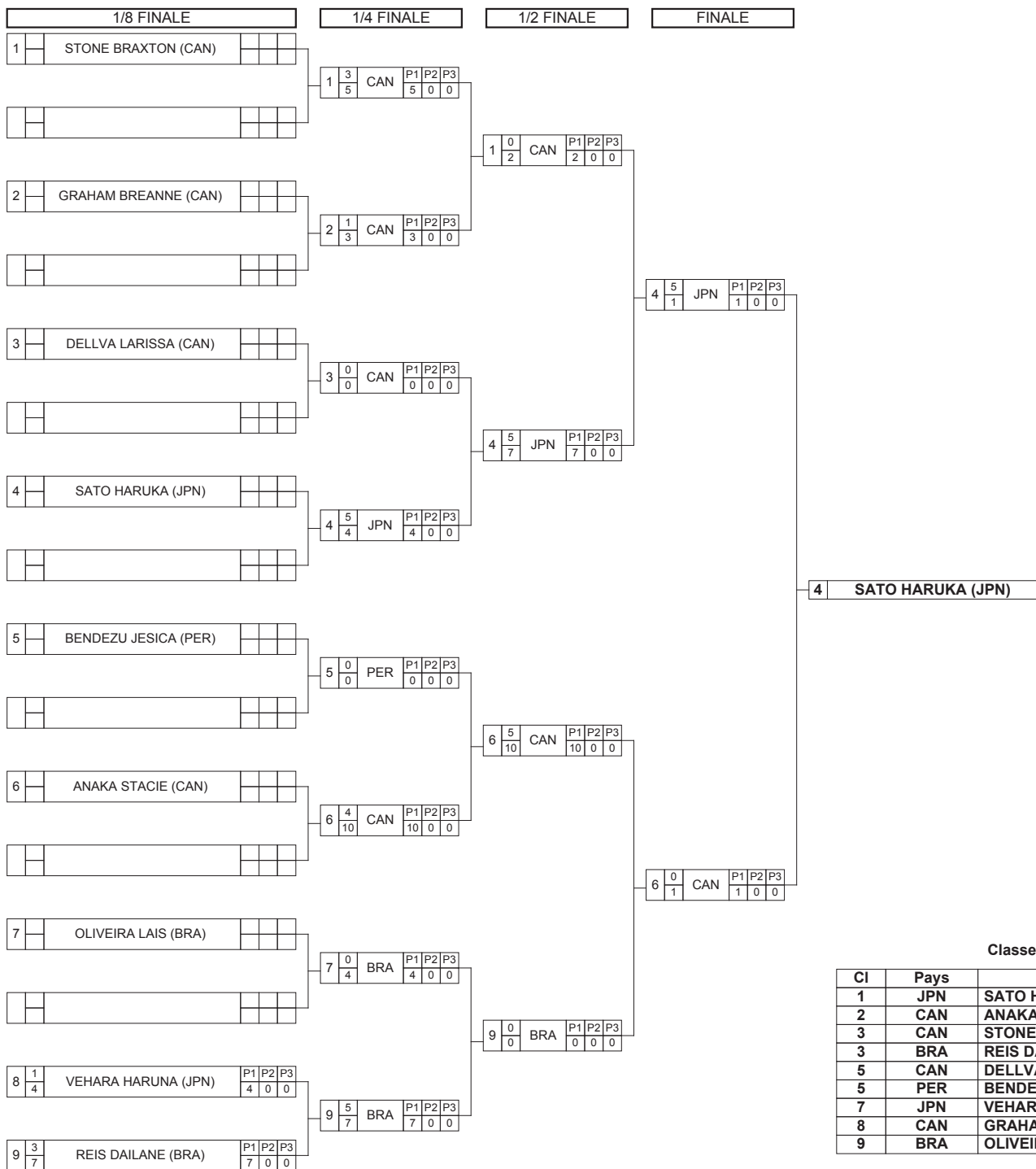

Classement

Cl	Pays	Nom
1	JPN	SATO HARUKA
2	CAN	ANAKA STACIE
3	CAN	STONE BRAXTON
3	BRA	REIS DAILANE
5	CAN	DELLVA LARISSA
5	PER	BENDEZU JESICA
7	JPN	VEHARA HARUNA
8	CAN	GRAHAM BREANNE
9	BRA	OLIVEIRA LAIS

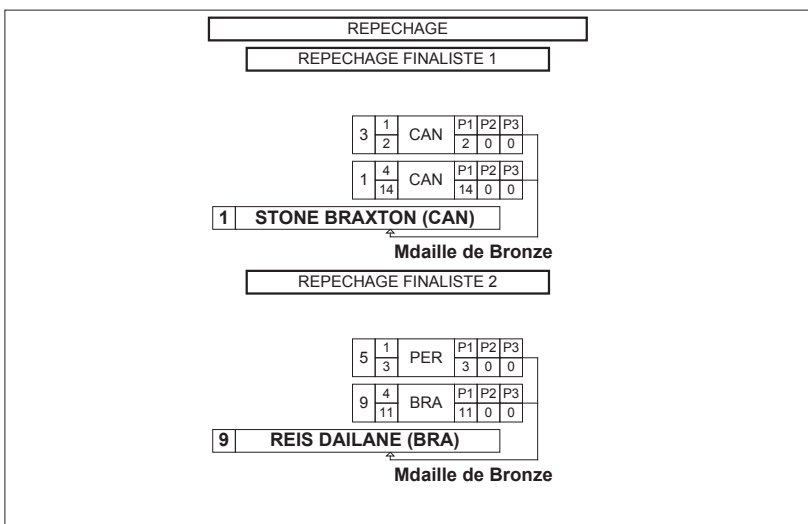



Classement

COPA BRASIL INTERNACIONAL 2014

STYLE : FW 63 kg



1 - Or / Gold



SATO HARUKA

2 - Argent / Silver



ANAKA STACIE

3 - Bronze



STONE BRAXTON



REIS DAILANE

<i>Classement</i>	<i>Nom - Name</i>	<i>Pays - Country</i>
1	SATO HARUKA	JPN
2	ANAKA STACIE	CAN
3	STONE BRAXTON	CAN
3	REIS DAILANE	BRA
5	DELLVA LARISSA	CAN
5	BENDEZU JESICA	PER
7	VEHARA HARUNA	JPN
8	GRAHAM BREANNE	CAN
9	OLIVEIRA LAIS	BRA



Feuille de compétition / Competition Sheet

COPA BRASIL INTERNACIONAL 2014

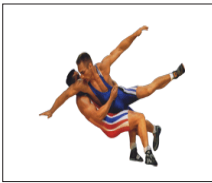

STYLE : FW 69 kg

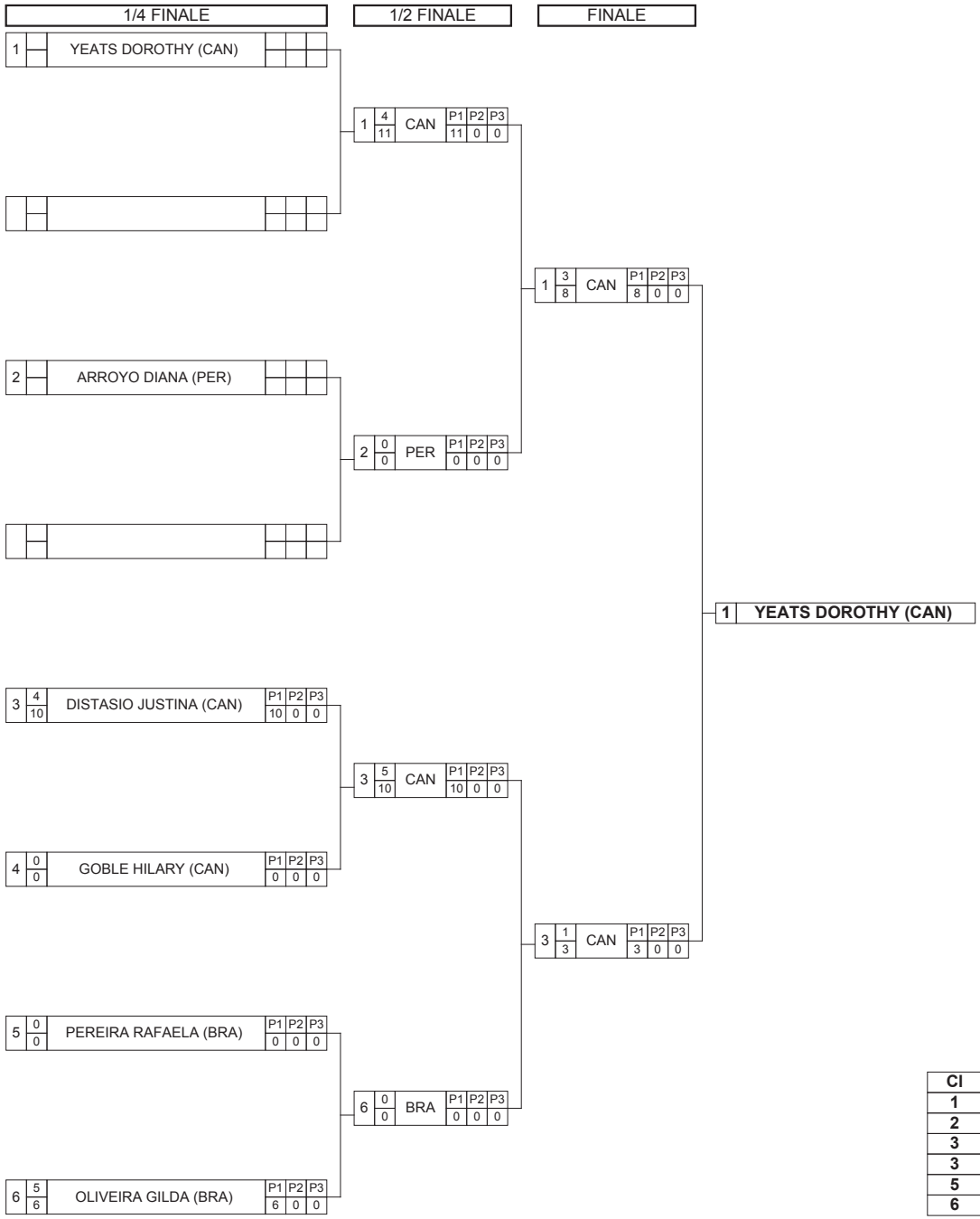

Classement

Cl	Pays	Nom
1	CAN	YEATS DOROTHY
2	CAN	DISTASIO JUSTINA
3	PER	ARROYO DIANA
3	CAN	GOBLE HILARY
5	BRA	OLIVEIRA GILDA
6	BRA	PEREIRA RAFAELA

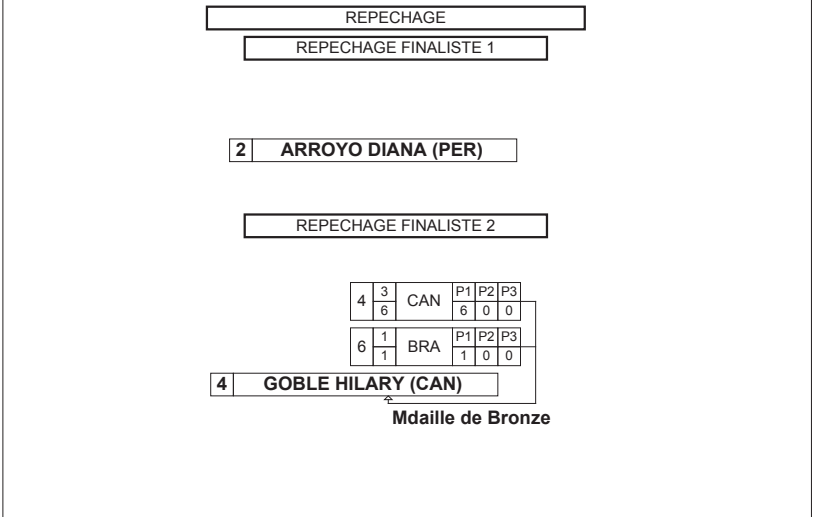



Classement

COPA BRASIL INTERNACIONAL 2014

STYLE : FW 69 kg



1 - Or / Gold



YEATS DOROTHY

2 - Argent / Silver



DISTASIO JUSTINA

3 - Bronze



ARROYO DIANA



GOBLE HILARY

<i>Classement</i>	<i>Nom - Name</i>	<i>Pays - Country</i>
1	YEATS DOROTHY	CAN
2	DISTASIO JUSTINA	CAN
3	ARROYO DIANA	PER
3	GOBLE HILARY	CAN
5	OLIVEIRA GILDA	BRA
6	PEREIRA RAFAELA	BRA



Feuille de compétition / Competition Sheet

COPA BRASIL INTERNACIONAL 2014

STYLE : FW 75 kg



TOUR : 1

1	4 6	ABE RINO (JPN)	P1 6	P2 0	P3 0	1	ABE RINO (JPN)
2	0 0	SILVA KEILA (BRA)	P1 0	P2 0	P3 0		
3	0 2	WIEBE ERICA (CAN)	P1 2	P2 0	P3 0	4	FERREIRA ALINE (BRA)
4	4 7	FERREIRA ALINE (BRA)	P1 7	P2 0	P3 0		

TOUR : 2

5	1 7	KEEFE VERONICA (CAN)	P1 7	P2 0	P3 0	1	ABE RINO (JPN)
1	4 11	ABE RINO (JPN)	P1 11	P2 0	P3 0		
2	0 0	SILVA KEILA (BRA)	P1 0	P2 0	P3 0	3	WIEBE ERICA (CAN)
3	4 10	WIEBE ERICA (CAN)	P1 10	P2 0	P3 0		

TOUR : 3

4	4 10	FERREIRA ALINE (BRA)	P1 10	P2 0	P3 0	4	FERREIRA ALINE (BRA)
1	0 2	ABE RINO (JPN)	P1 2	P2 0	P3 0		
5	4 10	KEEFE VERONICA (CAN)	P1 10	P2 0	P3 0	5	KEEFE VERONICA (CAN)
2	0 0	SILVA KEILA (BRA)	P1 0	P2 0	P3 0		

TOUR : 4

3	4 10	WIEBE ERICA (CAN)	P1 10	P2 0	P3 0	3	WIEBE ERICA (CAN)
1	0 0	ABE RINO (JPN)	P1 0	P2 0	P3 0		
4	1 3	FERREIRA ALINE (BRA)	P1 3	P2 0	P3 0	5	KEEFE VERONICA (CAN)
5	3 6	KEEFE VERONICA (CAN)	P1 6	P2 0	P3 0		

TOUR : 5

2	0 0	SILVA KEILA (BRA)	P1 0	P2 0	P3 0	4	FERREIRA ALINE (BRA)
4	4 0	FERREIRA ALINE (BRA)	P1 0	P2 0	P3 0		
3	3 9	WIEBE ERICA (CAN)	P1 9	P2 0	P3 0	3	WIEBE ERICA (CAN)
5	0 0	KEEFE VERONICA (CAN)	P1 0	P2 0	P3 0		

Classement

Cl	Pays	Nom	Points
1	BRA	FERREIRA ALINE	13
2	CAN	WIEBE ERICA	11
3	JPN	ABE RINO	8
4	CAN	KEEFE VERONICA	8
5	BRA	SILVA KEILA	0



Classement

COPA BRASIL INTERNACIONAL 2014

STYLE : FW 75 kg



1 - Or / Gold



FERREIRA ALINE

2 - Argent / Silver



WIEBE ERICA

3 - Bronze



ABE RINO

<i>Classement</i>	<i>Nom - Name</i>	<i>Pays - Country</i>	<i>Points</i>
1	FERREIRA ALINE	BRA	13
2	WIEBE ERICA	CAN	11
3	ABE RINO	JPN	8
4	KEEFE VERONICA	CAN	8
5	SILVA KEILA	BRA	0

COPA BRASIL INTERNACIONAL 2014



RIO DE JANEIRO (BRA)

2014-11-27 - 2014-11-29 2014

Résultats - Results

Lutte Greco-Romaine - Greco-Roman





Liste des arbitres / Referee list

COPA BRASIL INTERNACIONAL 2014



<i>N°</i>	<i>Licence</i>	<i>Pays Country</i>	<i>Nom - Last Name</i>	<i>Prénom - First Name</i>
-----------	----------------	-------------------------	------------------------	----------------------------



Liste des nations / Countries List

COPA BRASIL INTERNACIONAL 2014

STYLE GR

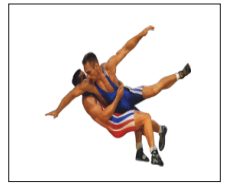

Pays - Country

	ARGENTINA	ARG
	BRAZIL	BRA
	CHILE	CHI
	ECUADOR	ECU
	JAPAN	JPN
	KAZAKHSTAN	KAZ
	PERU	PER
	SWEDEN	SWE

Nombre de nations - Number of Countries

**Nombre d'engagés par nation / Number of Entries By Country****COPA BRASIL INTERNACIONAL 2014**

STYLE GR



<i>Pays - Country</i>	130 KG	59 KG	66 KG	71 KG	75 KG	80 KG	85 KG	98 KG	TOTAL
ARG	1	1	1		1				4
BRA	1	2	4	3	1	2	4	2	19
CHI		1			1			1	3
ECU	1	1	1		1			1	5
JPN	1	1	1	1	1	1	1	1	8
KAZ		1							1
PER		1			1				2
SWE	1			1	1			1	4
TOTAL	5	8	7	5	7	3	5	6	46

Nombre de nations - Number of Countries **8**

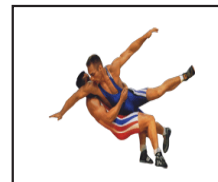
**Liste des Engagés par pays / Entry-List By Country****COPA BRASIL INTERNACIONAL 2014****STYLE GR****ARGENTINA (ARG)****Lutteur(s) / Wrestler(s) :**

130 kg	DEL RIO, LUCIANO
59 kg	LAKIS, MAXIMILIANO
66 kg	PEZZUTO, SANTIAGO
75 kg	OLIVEIRA, ELIAS

BRAZIL (BRA)**Lutteur(s) / Wrestler(s) :**

130 kg	PAZ, RAMILO
59 kg	MACHADO, ARLEY ROMANELLI, DIEGO
66 kg	FEITOSA, ANDRE LEON, GIL PEDROSA, KENEDY SANTOS, THIAGO
71 kg	ESTEVÃO, IURI FERREIRA, DANIEL WANDERLEY, WAGNER
75 kg	MORREIRA, ANGELO
80 kg	LIMA, TASSIO MOURA, RICHARD
85 kg	BRANDÃO, RONISSON DIAS, GUILERME MENDES, WANDERSON OLIVEIRA, YAGO
98 kg	ALBINO, DAVI KATO, ROBSON

CHILE (CHI)**Lutteur(s) / Wrestler(s) :**

59 kg	TORRES, CRISTOBAL
75 kg	GAMBOA, CLAUDIO
98 kg	GARCIA, CARLOS

ECUADOR (ECU)**Lutteur(s) / Wrestler(s) :**

130 kg	DELGADO, CARLOS
59 kg	MONTAÑO, ANDRES
66 kg	GUALLEPA, MILTON
75 kg	CUERO, ENRIQUE



Liste des Engagés par pays / Entry-List By Country

COPA BRASIL INTERNACIONAL 2014

STYLE GR



98 kg

OBANDO, LUIS

JAPAN (JPN)

Lutteur(s) / Wrestler(s) :

130 kg

SONODA, ARATA

59 kg

OTA, SHINOBU

66 kg

TAKAHASHI, SHOGO

71 kg

YABIKU, SHOHEI

75 kg

SAKABE, SO

80 kg

MAETA, YUYA

85 kg

SUMI, MASATO

98 kg

MAEKAWA, SHORI

KAZAKHSTAN (KAZ)

Lutteur(s) / Wrestler(s) :

59 kg

YERGANAT, BAIDAULETOV

PERU (PER)

Lutteur(s) / Wrestler(s) :

59 kg

ALEXANDER, CHRISTOPER

75 kg

MENDOONZA, RENZO

SWEDEN (SWE)

Lutteur(s) / Wrestler(s) :

130 kg

EUREN, JOHAN

71 kg

VARDANYAN, SHARUR

75 kg

ROSENGREM, ROBERT

98 kg

SCHON, FREDRIK



Feuille de compétition / Competition Sheet

COPA BRASIL INTERNACIONAL 2014

STYLE : GR 130 kg

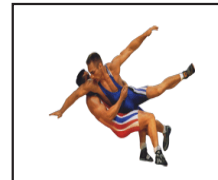

TOUR : 1

1	0	0	DEL RIO LUCIANO (ARG)	P1	P2	P3	}	2	PAZ RAMILO (BRA)
				0	0	0			
2	4	4	PAZ RAMILO (BRA)	P1	P2	P3	}		
				4	0	0			
3	4	6	EUREN JOHAN (SWE)	P1	P2	P3	}	3	EUREN JOHAN (SWE)
				6	0	0			
4	1	2	SONODA ARATA (JPN)	P1	P2	P3	}		
				2	0	0			

TOUR : 2

5	1	10	DELGADO CARLOS (ECU)	P1	P2	P3	}	1	DEL RIO LUCIANO (ARG)
				10	0	0			
1	3	14	DEL RIO LUCIANO (ARG)	P1	P2	P3	}		
				14	0	0			
2	0	0	PAZ RAMILO (BRA)	P1	P2	P3	}	3	EUREN JOHAN (SWE)
				0	0	0			
3	4	8	EUREN JOHAN (SWE)	P1	P2	P3	}		
				8	0	0			

TOUR : 3

4	4	8	SONODA ARATA (JPN)	P1	P2	P3	}	4	SONODA ARATA (JPN)
				8	0	0			
1	0	0	DEL RIO LUCIANO (ARG)	P1	P2	P3	}		
				0	0	0			
5	0	1	DELGADO CARLOS (ECU)	P1	P2	P3	}	2	PAZ RAMILO (BRA)
				1	0	0			
2	4	2	PAZ RAMILO (BRA)	P1	P2	P3	}		
				2	0	0			

TOUR : 4

3	4	1	EUREN JOHAN (SWE)	P1	P2	P3	}	3	EUREN JOHAN (SWE)
				1	0	0			
1	0	0	DEL RIO LUCIANO (ARG)	P1	P2	P3	}		
				0	0	0			
4	4	0	SONODA ARATA (JPN)	P1	P2	P3	}	4	SONODA ARATA (JPN)
				0	0	0			
5	0	0	DELGADO CARLOS (ECU)	P1	P2	P3	}		
				0	0	0			

TOUR : 5

2	0	0	PAZ RAMILO (BRA)	P1	P2	P3	}	4	SONODA ARATA (JPN)
				0	0	0			
4	4	8	SONODA ARATA (JPN)	P1	P2	P3	}		
				8	0	0			
3	4	0	EUREN JOHAN (SWE)	P1	P2	P3	}	3	EUREN JOHAN (SWE)
				0	0	0			
5	0	0	DELGADO CARLOS (ECU)	P1	P2	P3	}		
				0	0	0			

Classement

Cl	Pays	Nom	Points
1	SWE	EUREN JOHAN	16
2	JPN	SONODA ARATA	13
3	BRA	PAZ RAMILO	8
4	ARG	DEL RIO LUCIANO	3
5	ECU	DELGADO CARLOS	1



Classement

COPA BRASIL INTERNACIONAL 2014

STYLE : GR 130 kg



1 - Or / Gold



EUREN JOHAN

2 - Argent / Silver



SONODA ARATA

3 - Bronze



PAZ RAMILO

<i>Classement</i>	<i>Nom - Name</i>	<i>Pays - Country</i>	<i>Points</i>
1	EUREN JOHAN	SWE	16
2	SONODA ARATA	JPN	13
3	PAZ RAMILO	BRA	8
4	DEL RIO LUCIANO	ARG	3
5	DELGADO CARLOS	ECU	1



Feuille de compétition / Competition Sheet

COPA BRASIL INTERNACIONAL 2014

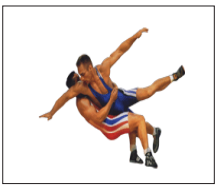

STYLE : GR 59 kg



Classement

Cl	Pays	Nom
1	JPN	OTA SHINOBU
2	BRA	ROMANELLI DIEGO
3	KAZ	YERGANAT BAIDAULETOV
3	ECU	MONTAA' O ANDRES
5	CHI	TORRES CRISTOBAL
5	PER	ALEXANDER CHRISTOPER
7	BRA	MACHADO ARLEY
8	ARG	LAKIS MAXIMILIANO

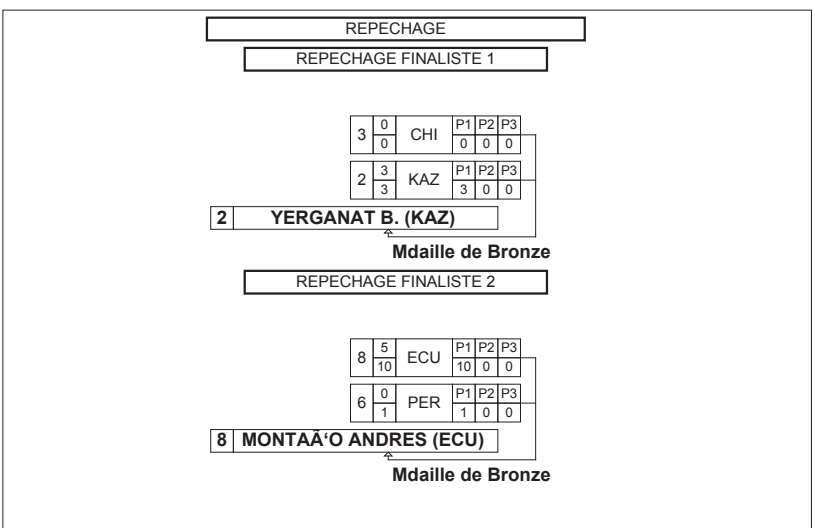



Classement

COPA BRASIL INTERNACIONAL 2014

STYLE : GR 59 kg



1 - Or / Gold



OTA SHINOBU

2 - Argent / Silver



ROMANELLI DIEGO

3 - Bronze



YERGANAT BAIDAULETOV



MONTAÑ'O ANDRES

Classement	Nom - Name	Pays - Country
1	OTA SHINOBU	JPN
2	ROMANELLI DIEGO	BRA
3	YERGANAT B.	KAZ
3	MONTAÑ'O ANDRES	ECU
5	TORRES CRISTOBAL	CHI
5	ALEXANDER C.	PER
7	MACHADO ARLEY	BRA
8	LAKIS MAXIMILIANO	ARG



Feuille de compétition / Competition Sheet

COPA BRASIL INTERNACIONAL 2014

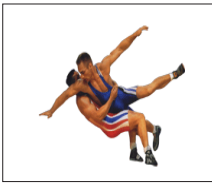

STYLE : GR 66 kg

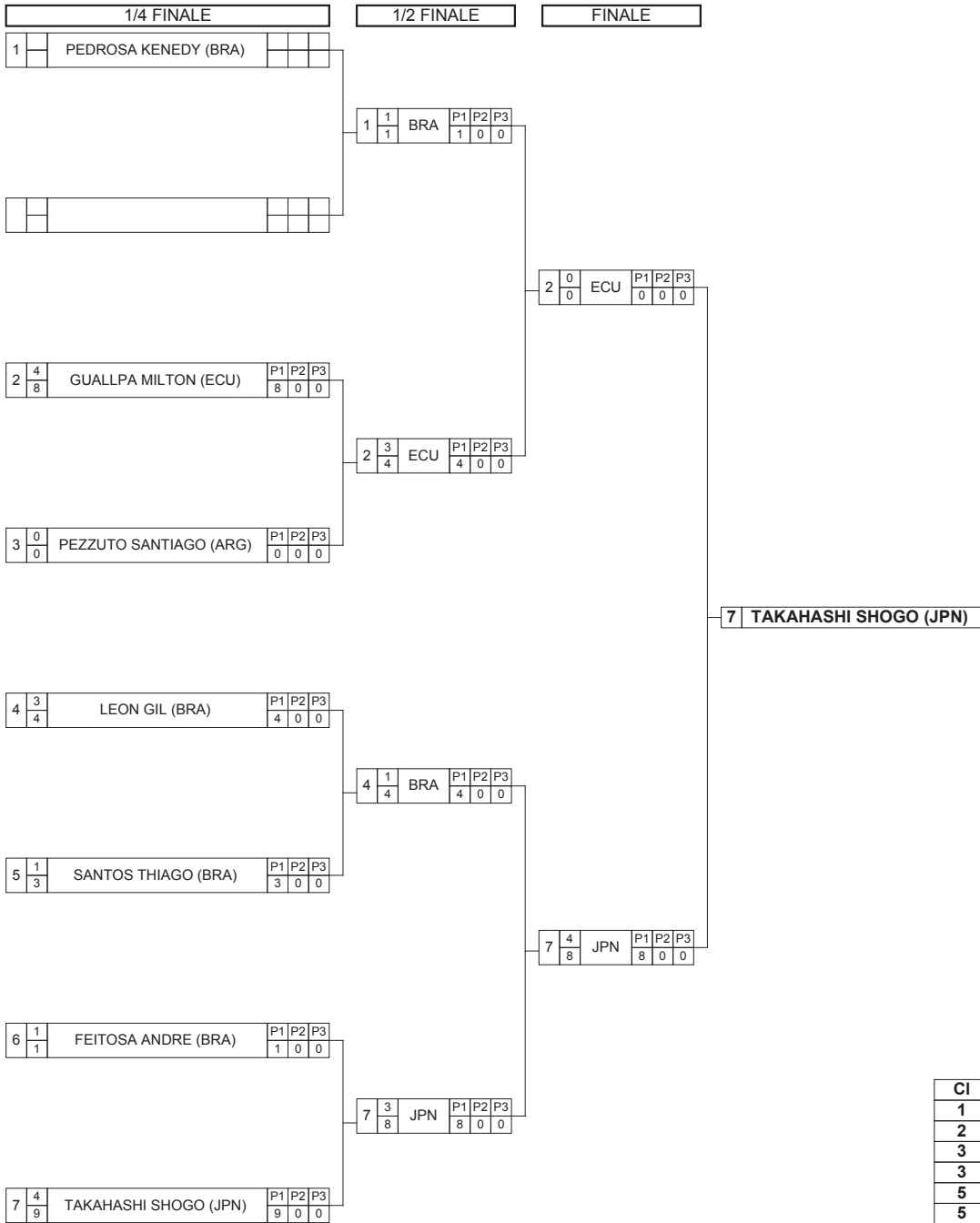

Classement

Cl	Pays	Nom
1	JPN	TAKAHASHI SHOGO
2	ECU	GUALLPA MILTON
3	BRA	PEDROSA KENEDY
3	BRA	LEON GIL
5	ARG	PEZZUTO SANTIAGO
5	BRA	FEITOSA ANDRE
7	BRA	SANTOS THIAGO

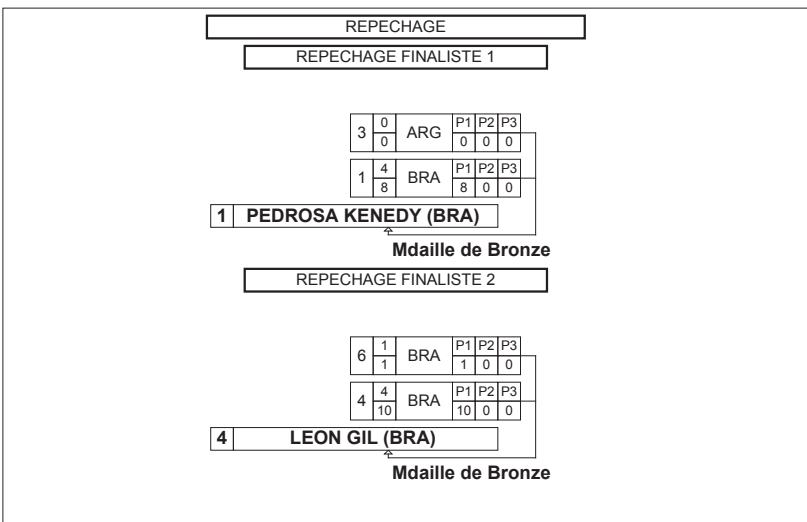



Classement

COPA BRASIL INTERNACIONAL 2014

STYLE : GR 66 kg



1 - Or / Gold



TAKAHASHI SHOGO

2 - Argent / Silver



GUALLPA MILTON

3 - Bronze



PEDROSA KENEDY



LEON GIL

Classement	Nom - Name	Pays - Country
1	TAKAHASHI SHOGO	JPN
2	GUALLPA MILTON	ECU
3	PEDROSA KENEDY	BRA
3	LEON GIL	BRA
5	PEZZUTO SANTIAGO	ARG
5	FEITOSA ANDRE	BRA
7	SANTOS THIAGO	BRA



Feuille de compétition / Competition Sheet

COPA BRASIL INTERNACIONAL 2014

STYLE : GR 71 kg



TOUR : 1

1	0 0	FERREIRA DANIEL (BRA)	P1 0	P2 0	P3 0	2	YABIKU SHOHEI (JPN)
2	4 8	YABIKU SHOHEI (JPN)	P1 8	P2 0	P3 0		
3	4 4	WANDERLEY WAGNER (BRA)	P1 4	P2 0	P3 0	3	WANDERLEY WAGNER (BRA)
4	0 4	ESTEVÃO IURI (BRA)	P1 4	P2 0	P3 0		

TOUR : 2

5	4 8	VARDANYAN SHARUR (SWE)	P1 8	P2 0	P3 0	5	VARDANYAN SHARUR (SWE)
1	0 0	FERREIRA DANIEL (BRA)	P1 0	P2 0	P3 0		
2	4 11	YABIKU SHOHEI (JPN)	P1 11	P2 0	P3 0	2	YABIKU SHOHEI (JPN)
3	1 4	WANDERLEY WAGNER (BRA)	P1 4	P2 0	P3 0		

TOUR : 3

4	3 2	ESTEVÃO IURI (BRA)	P1 2	P2 0	P3 0	4	ESTEVÃO IURI (BRA)
1	0 0	FERREIRA DANIEL (BRA)	P1 0	P2 0	P3 0		
5	0 0	VARDANYAN SHARUR (SWE)	P1 0	P2 0	P3 0	2	YABIKU SHOHEI (JPN)
2	4 8	YABIKU SHOHEI (JPN)	P1 8	P2 0	P3 0		

TOUR : 4

3	1 3	WANDERLEY WAGNER (BRA)	P1 3	P2 0	P3 0	1	FERREIRA DANIEL (BRA)
1	3 3	FERREIRA DANIEL (BRA)	P1 3	P2 0	P3 0		
4	1 6	ESTEVÃO IURI (BRA)	P1 6	P2 0	P3 0	5	VARDANYAN SHARUR (SWE)
5	4 10	VARDANYAN SHARUR (SWE)	P1 10	P2 0	P3 0		

TOUR : 5

2	4 8	YABIKU SHOHEI (JPN)	P1 8	P2 0	P3 0	2	YABIKU SHOHEI (JPN)
4	0 0	ESTEVÃO IURI (BRA)	P1 0	P2 0	P3 0		
3	0 0	WANDERLEY WAGNER (BRA)	P1 0	P2 0	P3 0	5	VARDANYAN SHARUR (SWE)
5	4 6	VARDANYAN SHARUR (SWE)	P1 6	P2 0	P3 0		

Classement

Cl	Pays	Nom	Points
1	JPN	YABIKU SHOHEI	16
2	SWE	VARDANYAN SHARUR	12
3	BRA	WANDERLEY WAGNER	6
4	BRA	ESTEVÃO IURI	4
5	BRA	FERREIRA DANIEL	3



Classement

COPA BRASIL INTERNACIONAL 2014

STYLE : GR 71 kg



1 - Or / Gold



YABIKU SHOHEI

2 - Argent / Silver



VARDANYAN SHARUR

3 - Bronze



WANDERLEY WAGNER

<i>Classement</i>	<i>Nom - Name</i>	<i>Pays - Country</i>	<i>Points</i>
1	YABIKU SHOHEI	JPN	16
2	VARDANYAN SHARUR	SWE	12
3	WANDERLEY WAGNER	BRA	6
4	ESTEVÃO IURI	BRA	4
5	FERREIRA DANIEL	BRA	3



Feuille de compétition / Competition Sheet

COPA BRASIL INTERNACIONAL 2014



STYLE : GR 75 kg

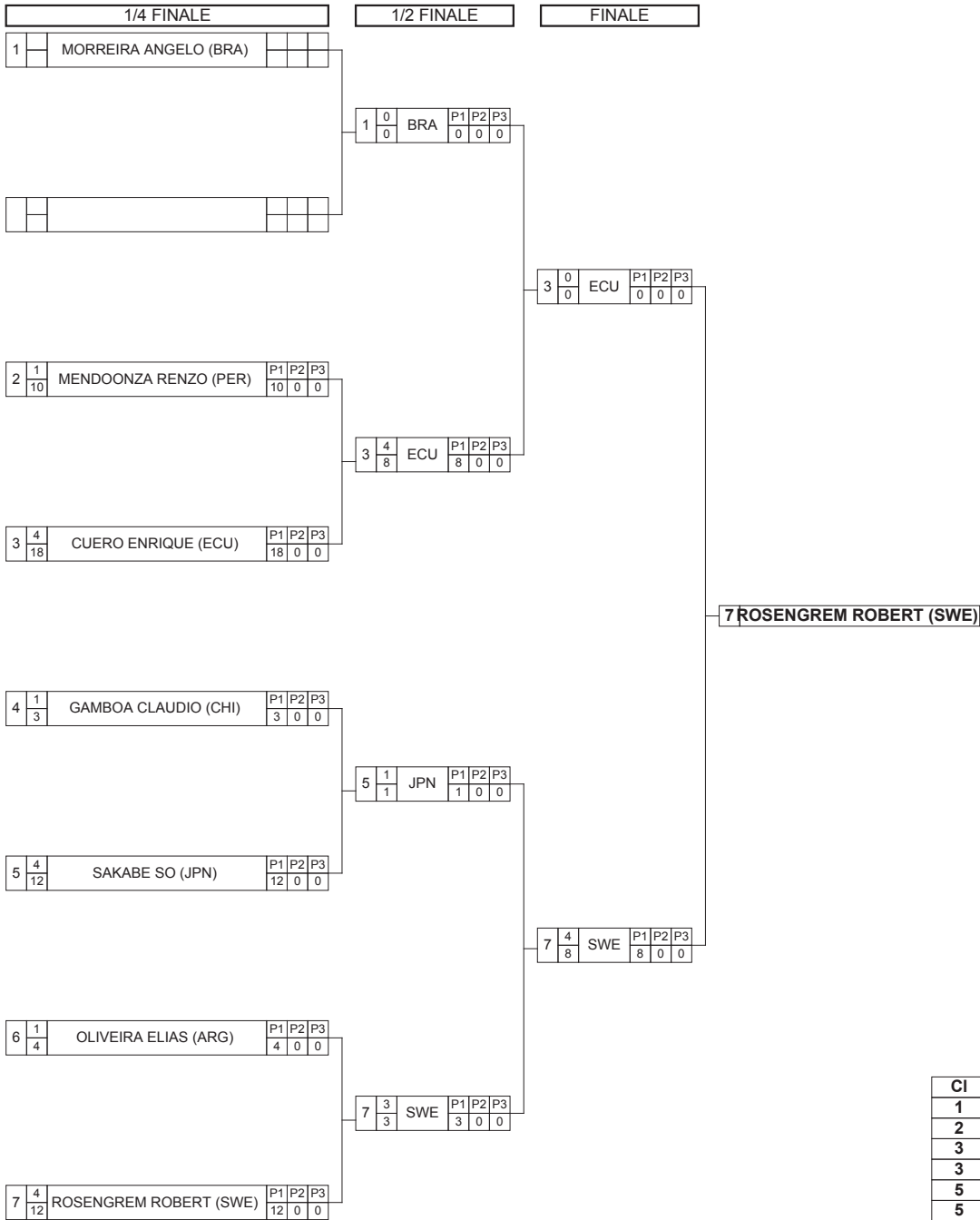

Classement

Cl	Pays	Nom
1	SWE	ROSENGREM ROBERT
2	ECU	CUERO ENRIQUE
3	BRA	MORREIRA ANGELO
3	JPN	SAKABE SO
5	PER	MENDOONZA RENZO
5	ARG	OLIVEIRA ELIAS
7	CHI	GAMBOA CLAUDIO

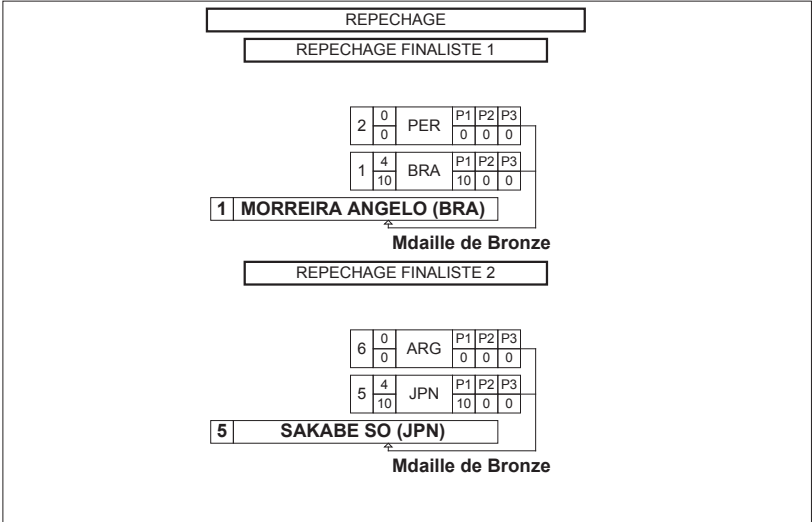



Classement

COPA BRASIL INTERNACIONAL 2014

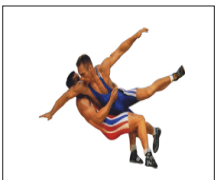

STYLE : GR 75 kg

1 - Or / Gold



ROSENGREM ROBERT

2 - Argent / Silver



CUERO ENRIQUE

3 - Bronze



MORREIRA ANGELO



SAKABE SO

<i>Classement</i>	<i>Nom - Name</i>	<i>Pays - Country</i>
1	ROSENGREM ROBERT	SWE
2	CUERO ENRIQUE	ECU
3	MORREIRA ANGELO	BRA
3	SAKABE SO	JPN
5	MENDOONZA RENZO	PER
5	OLIVEIRA ELIAS	ARG
7	GAMBOA CLAUDIO	CHI



Feuille de compétition / Competition Sheet

COPA BRASIL INTERNACIONAL 2014

STYLE : GR 80 kg



TOUR : 1

1	1	LIMA TASSIO (BRA)	P1	P2	P3	2	MAETA YUYA (JPN)
	1		1	0	0		
2	4	MAETA YUYA (JPN)	P1	P2	P3		
	10		10	0	0		

TOUR : 2

3	0	MOURA RICHARD (BRA)	P1	P2	P3	1	LIMA TASSIO (BRA)
	0		0	0	0		
1	4	LIMA TASSIO (BRA)	P1	P2	P3		
	8		8	0	0		

TOUR : 3

2	4	MAETA YUYA (JPN)	P1	P2	P3	2	MAETA YUYA (JPN)
	4		4	0	0		
3	0	MOURA RICHARD (BRA)	P1	P2	P3		
	0		0	0	0		

Classement

Cl	Pays	Nom	Points
1	JPN	MAETA YUYA	8
2	BRA	LIMA TASSIO	5
3	BRA	MOURA RICHARD	0



Classement

COPA BRASIL INTERNACIONAL 2014

STYLE : GR 80 kg



1 - Or / Gold



MAETA YUYA

2 - Argent / Silver



LIMA TASSIO

3 - Bronze



MOURA RICHARD

<i>Classement</i>	<i>Nom - Name</i>	<i>Pays - Country</i>	<i>Points</i>
1	MAETA YUYA	JPN	8
2	LIMA TASSIO	BRA	5
3	MOURA RICHARD	BRA	0



Feuille de compétition / Competition Sheet

COPA BRASIL INTERNACIONAL 2014

STYLE : GR 85 kg



TOUR : 1

1	0 0	OLIVEIRA YAGO (BRA)	P1 0	P2 0	P3 0	2 MENDES WANDERSON (BRA)
2	4 8	MENDES WANDERSON (BRA)	P1 8	P2 0	P3 0	

3	0 0	DIAS GUILERME (BRA)	P1 0	P2 0	P3 0	4 BRANDÃO RONISSON (BRA)
4	3 3	BRANDÃO RONISSON (BRA)	P1 3	P2 0	P3 0	

TOUR : 2

5	4 4	SUMI MASATO (JPN)	P1 4	P2 0	P3 0	5 SUMI MASATO (JPN)
1	0 0	OLIVEIRA YAGO (BRA)	P1 0	P2 0	P3 0	

2	3 22	MENDES WANDERSON (BRA)	P1 22	P2 0	P3 0	2 MENDES WANDERSON (BRA)
3	1 15	DIAS GUILERME (BRA)	P1 15	P2 0	P3 0	

TOUR : 3

4	4 2	BRANDÃO RONISSON (BRA)	P1 2	P2 0	P3 0	4 BRANDÃO RONISSON (BRA)
1	0 0	OLIVEIRA YAGO (BRA)	P1 0	P2 0	P3 0	

5	4 9	SUMI MASATO (JPN)	P1 9	P2 0	P3 0	5 SUMI MASATO (JPN)
2	0 0	MENDES WANDERSON (BRA)	P1 0	P2 0	P3 0	

TOUR : 4

3	0 0	DIAS GUILERME (BRA)	P1 0	P2 0	P3 0	1 OLIVEIRA YAGO (BRA)
1	4 0	OLIVEIRA YAGO (BRA)	P1 0	P2 0	P3 0	

4	0 0	BRANDÃO RONISSON (BRA)	P1 0	P2 0	P3 0	5 SUMI MASATO (JPN)
5	4 8	SUMI MASATO (JPN)	P1 8	P2 0	P3 0	

TOUR : 5

2	0 0	MENDES WANDERSON (BRA)	P1 0	P2 0	P3 0	4 BRANDÃO RONISSON (BRA)
4	4 0	BRANDÃO RONISSON (BRA)	P1 0	P2 0	P3 0	

3	0 0	DIAS GUILERME (BRA)	P1 0	P2 0	P3 0	5 SUMI MASATO (JPN)
5	4 0	SUMI MASATO (JPN)	P1 0	P2 0	P3 0	

Classement

Cl	Pays	Nom	Points
1	JPN	SUMI MASATO	16
2	BRA	BRANDÃO RONISSON	11
3	BRA	MENDES WANDERSON	7
4	BRA	OLIVEIRA YAGO	4
5	BRA	DIAS GUILERME	1



Classement

COPA BRASIL INTERNACIONAL 2014

STYLE : GR 85 kg



1 - Or / Gold



SUMI MASATO

2 - Argent / Silver



BRANDÃO RONISSON

3 - Bronze



MENDES WANDERSON

Classement	Nom - Name	Pays - Country	Points
1	SUMI MASATO	JPN	16
2	BRANDÃO RONISSON	BRA	11
3	MENDES WANDERSON	BRA	7
4	OLIVEIRA YAGO	BRA	4
5	DIAS GUILERME	BRA	1



Feuille de compétition / Competition Sheet

COPA BRASIL INTERNACIONAL 2014

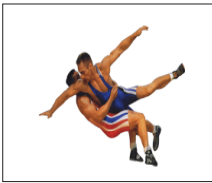

STYLE : GR 98 kg

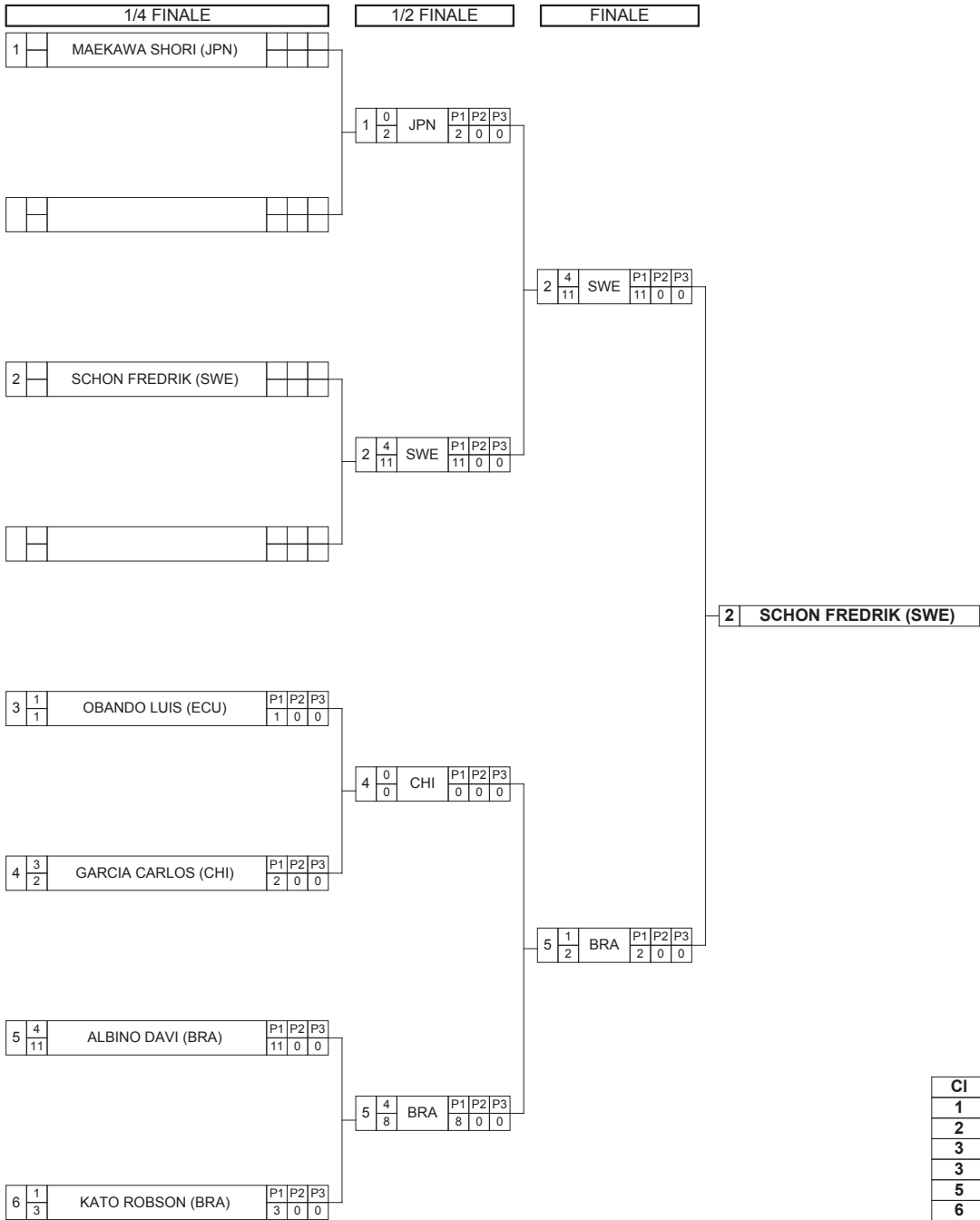

Classement

Cl	Pays	Nom
1	SWE	SCHON FREDRIK
2	BRA	ALBINO DAVI
3	CHI	GARCIA CARLOS
3	JPN	MAEKAWA SHORI
5	BRA	KATO ROBSON
6	ECU	OBANDO LUIS

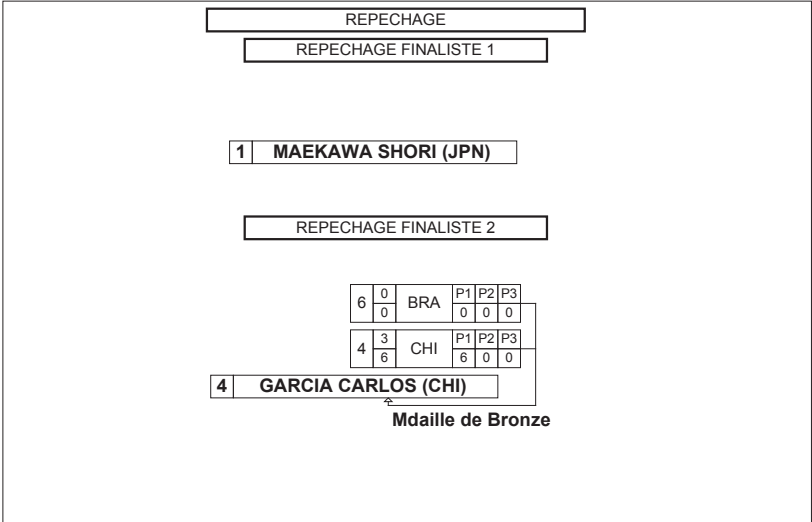



Classement

COPA BRASIL INTERNACIONAL 2014

STYLE : GR 98 kg



1 - Or / Gold



SCHON FREDRIK

2 - Argent / Silver



ALBINO DAVI

3 - Bronze



GARCIA CARLOS



MAEKAWA SHORI

<i>Classement</i>	<i>Nom - Name</i>	<i>Pays - Country</i>
1	SCHON FREDRIK	SWE
2	ALBINO DAVI	BRA
3	GARCIA CARLOS	CHI
3	MAEKAWA SHORI	JPN
5	KATO ROBSON	BRA
6	OBANDO LUIS	ECU



Classement par équipe / Teams ranking

COPA BRASIL INTERNACIONAL 2014

STYLE GR



Rang	Equipe	130 KG	59 KG	66 KG	71 KG	75 KG	80 KG	85 KG	98 KG	TOTAL
1	BRA	8	13	26	21	8	17	30	15	138
2	JPN	9	10	10	10	8	10	10	8	75
3	SWE	10			9	10			10	39
4	ECU	6	8	9		9			5	37
5	ARG	7	3	6		6				22
6	CHI		6			4			8	18
7	PER		6			6				12
8	KAZ		8							8